

Open Water Diver Manual

Stars



Index

Orientation 1



Transform into a Fish on Your Holidays . . . 3

Certificate of Fitness for Diving 4

Certification Card (C-Card) 5

Dive Equipment 7



Mask 9

Snorkel 11

Fins 12

Gloves 13



Boots 13

Diving suits 14

Weights 16

Tank 17



Regulator 19

Backup Scuba 20

BC 21

Gauge 23



Other Equipment 23

Gear Preparation 28

Equipment Maintenance 29

Underwater Environment 31

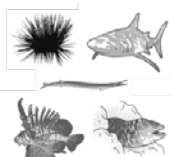

Topography and Artificial Structures . . . 33

Ocean Conditions 36

Poisonous Sea Life 40

Aggressive Sea Life 45

Underwater Physiology 47



Light and Color 49

Sound 50

Drag 51

Buoyancy 51

Heat Absorption 52

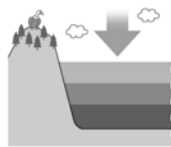

Air Composition 53

Breathing and Circulation Mechanism . . 53

Diver Breathing 54

Air Consumption 54

Pressure 55

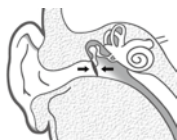

Pressure and Gas Volume 55

Lung Over-expansion Injury 56

Air Embolism 56

Gas Poisoning 57



Hyperventilation 59

Skip Breathing 60

Decompression Sickness (DCS) 61

The Human Body's Air Spaces 63

Squeeze and Equalization 65



Specific Squeeze Types 65

Reverse Block and Equalization 69

Specific Body Air Cavities and Reverse Block69

Plan and Rules 71



- Diving Site Selection 73
- Leader and Member 73
- Buddy System 74
- Equipment 74
- Health Maintenance 75
- Refresher Course 75
- Cancellation and Modification 76
- Emergency Plan 76
- Communication 77
- Air Consumption Ratio 80
- Dive Table 81
 - Change of the internal nitrogen quantity 82
 - Comparison of the internal nitrogen quantity 84
 - Constitution of the Dive Table 86
 - No-decompression Dive Limit 87
 - Residual Group 88
 - Surfacing Time 89
 - Nitrogen Disappearance Time 90
 - Surface Interval Time 92
 - No-decompression Dive Limit for the second diving 93
 - Residual Nitrogen Time 94
 - Residual Group for the second diving 95
 - Decompression Stop 96
 - Safety Stop 97
 - Time Until Safe To Fly 98
 - Other attention 102
 - Work Sheet 102
- Making a Dive Plan 105
- Multi-Level Diving 106
- Manners 109

Diving Skills 111

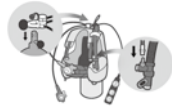

Donning Snorkel Set 113

Snorkel Clear 114

Fin Work 114

Donning the Weight Belt 115



Head First 116

Equipment Setup 117

Entry 119

Descent 121

Regulator Clear 123



Mask Clear 124

Regulator Recovery 125

Buoyancy Control 126

BC Donning and Removal 127

Weight Belt Donning and Removal . . . 129



Equipment Release 130

Dealing with Emergencies 131

Orientation

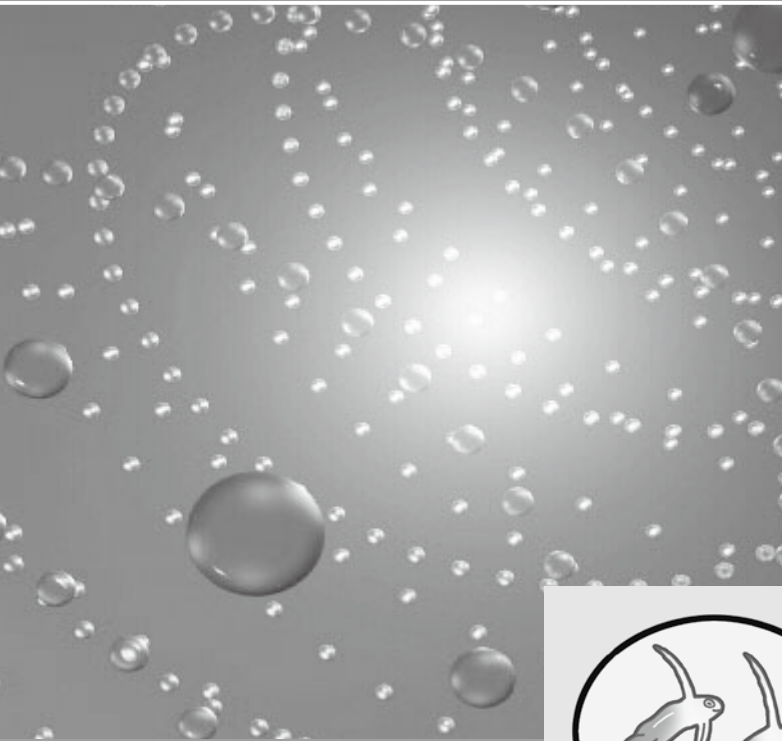

●●● Orientation ●●●

Welcome to the undersea world!

After finishing your course, the sea will become your world, too

By listening carefully to your instructor, you'll enjoyably master diving.



Transform into a Fish on your Holidays

The underwater world forever astonishes. Playing colorful fish, majestic topography, treasure hunting, it is a deeply moving place. This course allows you to master how to safely enjoy this deeply moving underwater world.

This course consists of a study portion and a practical skills training portion. In your studies, you learn to safely dive by mastering essential information. In practical skills training, employing your knowledge you will practice in shallow water. After completing this skills training, it's time for open water practice. During open water practice, in a real diving environment, you'll confirm you've mastered practical diving skills. After finishing the open water course work, your instructor will guide you around or help you to continue your training - either way, we'll help you in your transformation into a fish!

To improve while enjoying diving more, even after your course, if there is anything you'd like to know, please ask your instructor. Will you be able to talk with fishes someday?

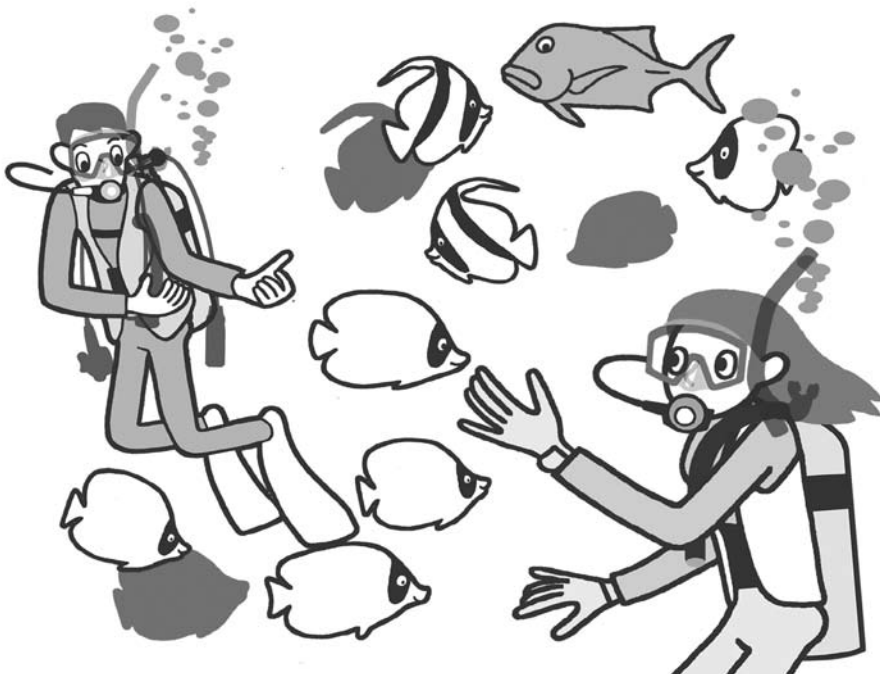

Certificate of Fitness for Diving

To dive, body and mind must both be sound. If you have any of the following illnesses or symptoms, a valid doctor's medical certificate clearing you for diving must be presented to the partner dive shop before any diving orientation, practical skills training, diving tours and the like can be undertaken (please consult with your instructor):

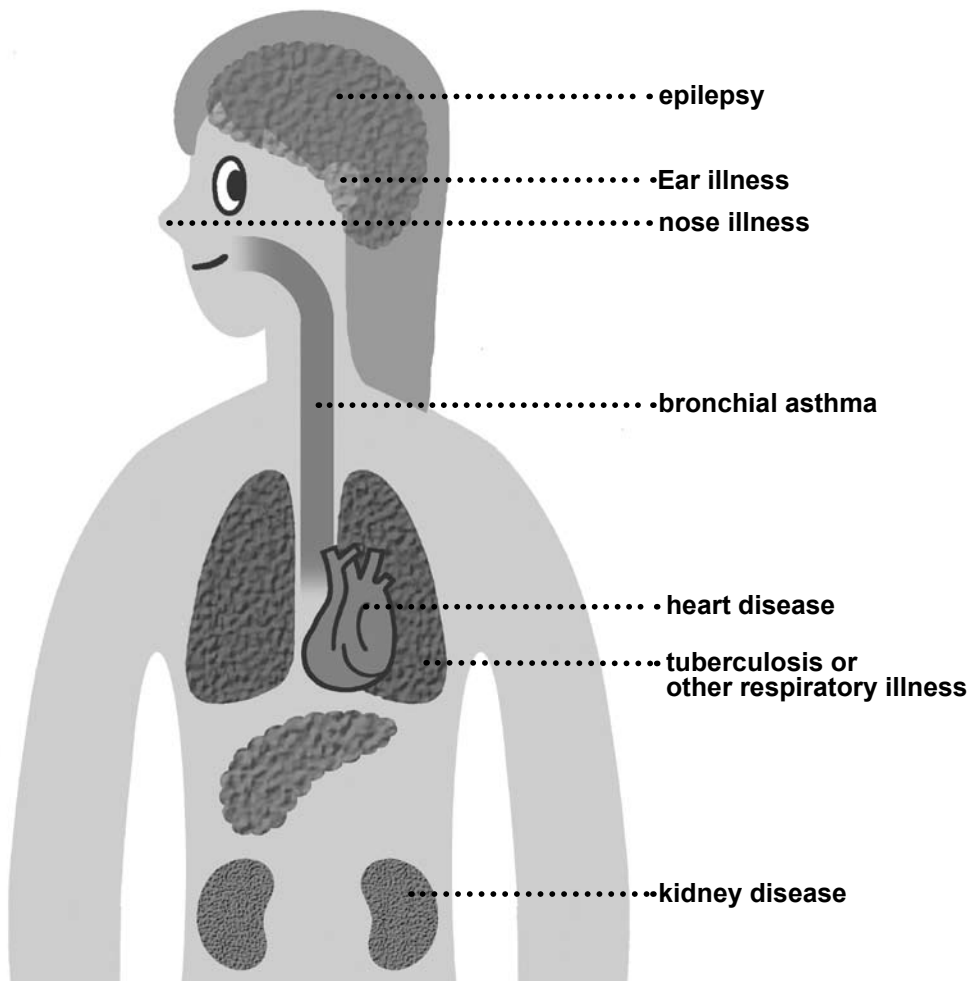

other ailments / high blood pressure / diabetes / highly sensitive allergies.

Certification Card (C-Card)

Upon completing the course you will receive the STARS C-Card.

This card certifies your diving ability, and since the CMAS card is international as well, please don't forget to bring it with you when you leave for abroad!



STARS Certification Card

Dive Equipment

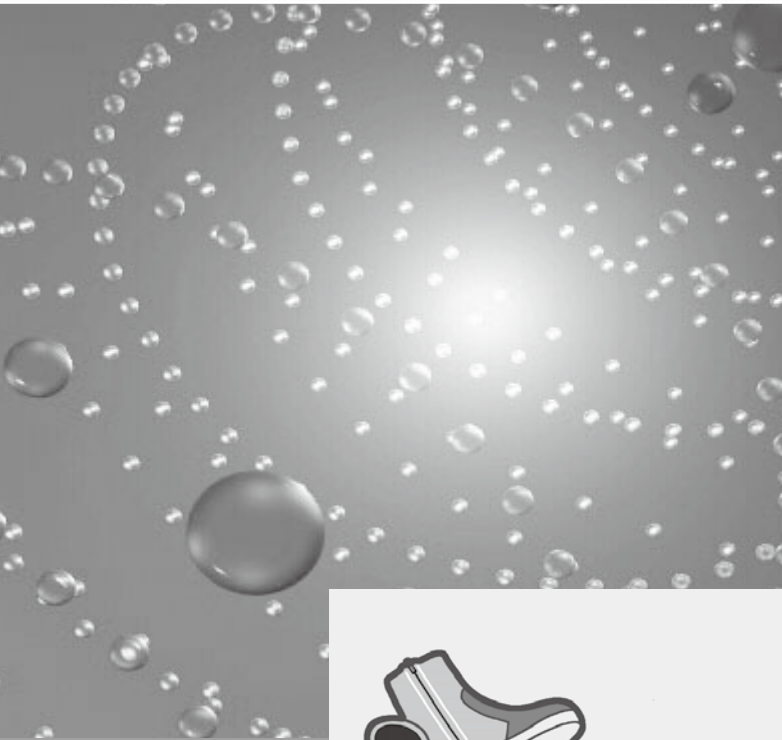

●●●Dive Equipment●●●

In SCUBA diving, we rely on upon a large amount of equipment. Let's look in detail at the features of this equipment. In consultation with your instructor, you can choose the equipment best suited to you. Becoming accustomed to your own equipment is the first step to safely enjoying the undersea world.

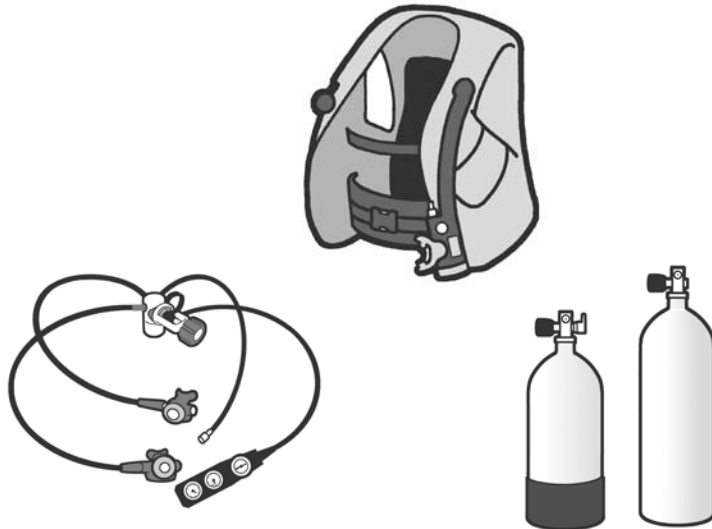

Originally designed for snorkeling / skin diving, lightweight equipment has become the standard for SCUBA diving. When purchasing or renting, a “snorkel set” consists of mask, snorkel and fins (three items) and a “full set” sees gloves and boots added to make five items. Combining a BC, regulator, octopus and gauge (usually pressure, may include depth and/or compass as well) round out the minimum gear for SCUBA.

Mask

In order to clearly see underwater, it is necessary to have airspace between your eyes and the water around you. Masks employ lenses made from tempered glass. It is also possible to have prescription lenses made for your mask. Also, your nose always needs to be contained inside the airspace area of the mask, so swimming goggles are not suitable for diving. To choose the best fitting mask, we hold it to our face, lightly inhale using our nose, and release our hold to see if a firm seal can be maintained. The field of vision should be as wide as possible. For its ability to fit well and to keep out water as well as its durability, silicon rubber masks are popular.



2-Lense Mask



1-Lense Mask



Multifaceted Mask

●●● Dive Equipment ●●●

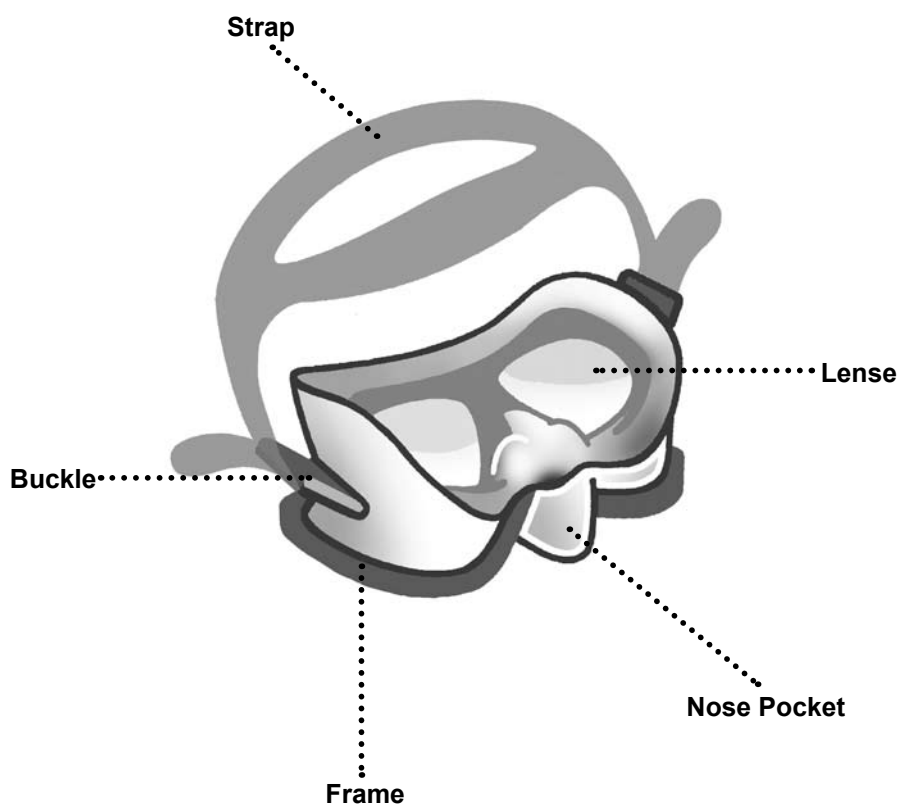

Snorkel

Using a snorkel allows us to breathe while keeping our face submerged. Since we do not have to raise our face out the water while continuing to breathe, when swimming across the surface of the water we conserve both our strength and tank air. Snorkels with a purge valve - to help clear the tube - are very common these days. We mount the snorkel to the mask strap on the left side of the mask. It is best to choose a snorkel with has a soft but durable mouthpiece - usually silicone. To match lung capacity, women's and children's snorkels are also available.

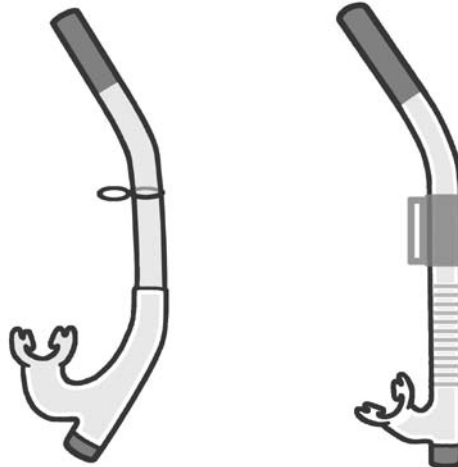

Fins

By using fins we get effective propulsive power in the water, since we don't use our hands in order to keep them free for other tasks. Easily removable strap-type and easily motile full boot-type fins are used. Materials for the blade include rubber, lightweight plastics, and urethane. It is important to choose your fins carefully for what suits you best, as there is a variety of styles. In general, flexible blades are preferred over hard blades by beginners.

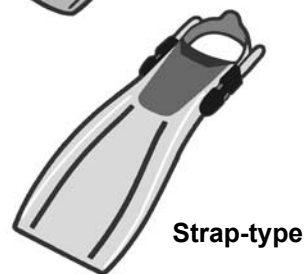
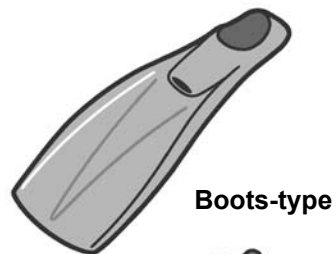
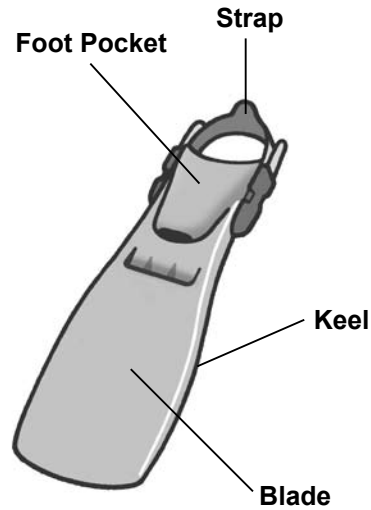

Gloves

Since our skin softens the longer we are underwater, we can easily get injured on rocks and such. Further, due to the risk from poisonous sea life, we can protect ourselves by always wearing gloves. There are highly insulated gloves for cold water conditions available, too.

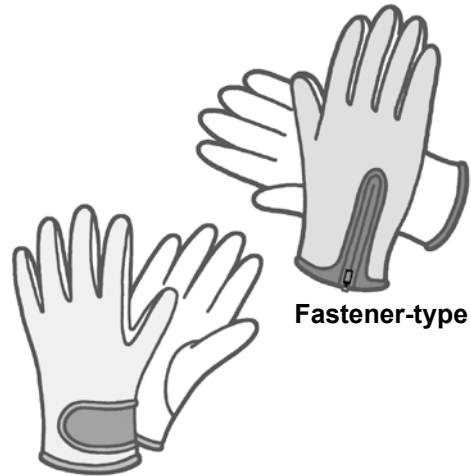

Velcro-type

Fastener-type

Boots

Boots fulfill the function of footwear, sure, but they protect and warm our feet underwater as well. It is best to choose those with a non-slip sole.



Deck Sole

Calendar Sole

Types of Diving Suits

Underwater, we can easily suffer heat loss, so to prevent this heat loss it is important to wear a diving suit. Thus the principal aims of a diving suit are heat retention, body protection and buoyancy. So please choose your diving suit according to the expected water temperature.

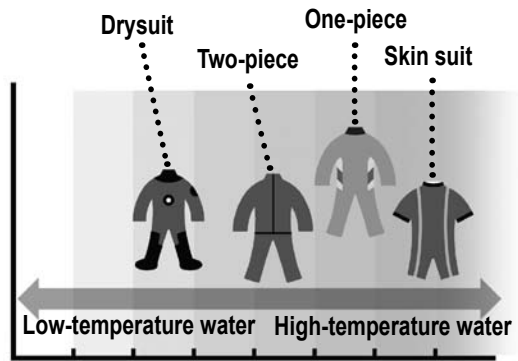

Diving Suit Type and Water Temperature

Wetsuits

Made from neoprene, inside are a great number of air bubbles that retain heat while providing more buoyancy than rubber. Order-made neoprene wetsuits provide the maximum amount of heat retention by fitting your body perfectly.

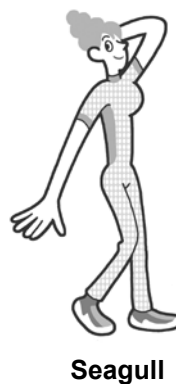
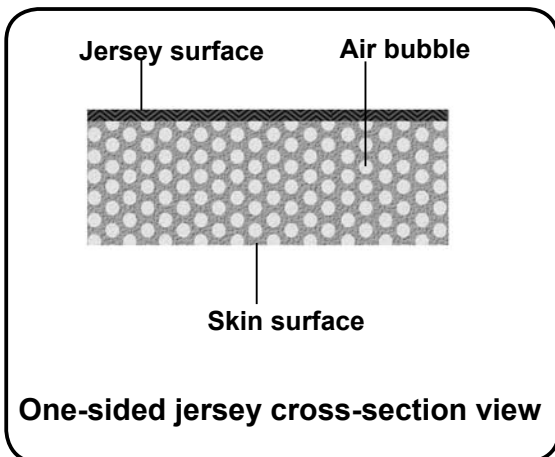
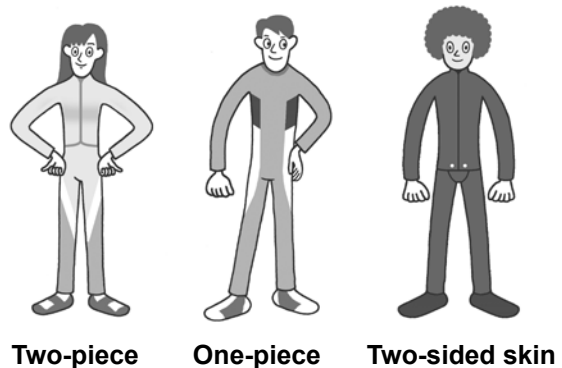

Drysuits

Since drysuits provide a barrier between your skin and the water, drysuits offer the highest heat retention of diving suits. Derived from neoprene or nylon, they offer motility and comfort while inlet and exhaust valves (located on the legs) allow for fine control.

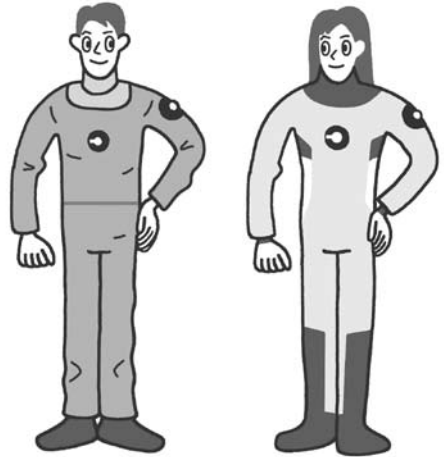

Nylon-type

Neoprene-type

Hood

Since In water we lose over 50% of our body heat from head and neck areas, in cool or cold water we need to use a hood. If we wear a vest with attached hood, we magnify our heat retention ability greatly.

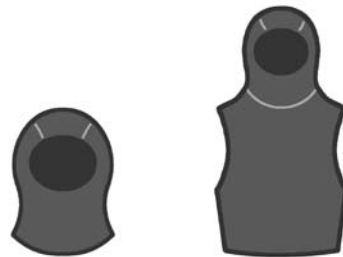

Hood

Vest with Attached Hood

Weights

The combination of diving suit, tank, BC and such increase our buoyancy, making it harder to descend. Thus we use weights to offset this increased buoyancy to make it easier to dive.

Made of lead and coming in 1kg, 1.5kg, and 2 kg, we wear the weights around our waist on a weight belt (though some new BCs incorporate a weight system into the BC itself).

The use of a quick release buckle allows for one-handed release in times of emergency.

We vary the weights according to the type of diving suits worn, equipment used, and so on, to maximize neutral buoyancy.

Ankle weights are used with drysuits only.

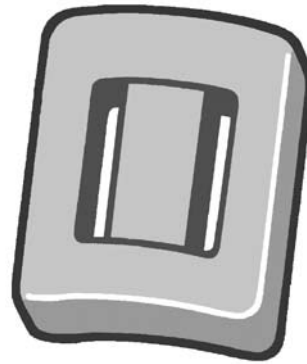

Weights

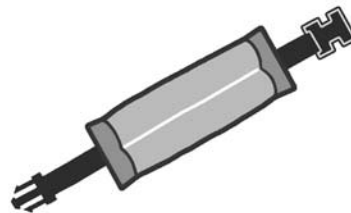

Ankle weights

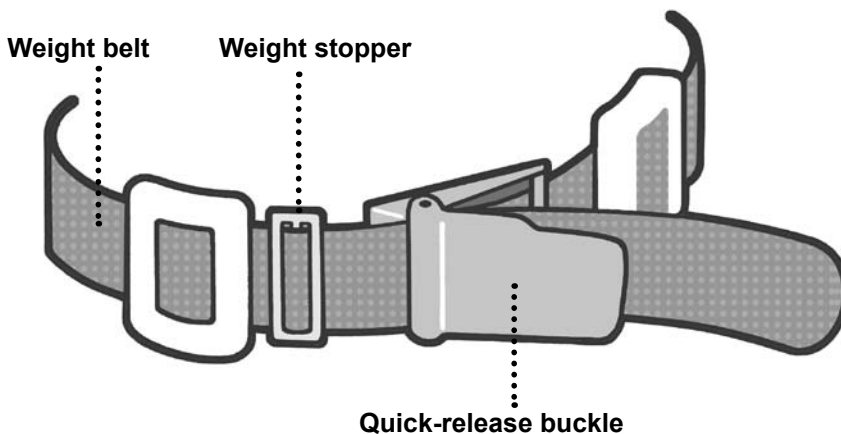

Tanks

In order to breathe air underwater, we compress air at high pressure inside a tank. Made of either aluminium or steel, in Japan all tanks require a hydrostatic (pressure-resistance) test every 3 years (for aluminium) or 5 years (for steel), based on the original manufacturing date.

Air is filled and used by way of a valve. The standard valve is now the K valve, but the J valve with a reserve lever is also used, if rarely, nowadays. When the air pressure in a tank using a J valve drops to below anywhere from 20-40 bar, the valve begins to close, increasing breathing resistance and one must manually pull a lever to restore air flow.

But with the widespread use of pressure gauges, the J valve is becoming an uncommon sight in diving.

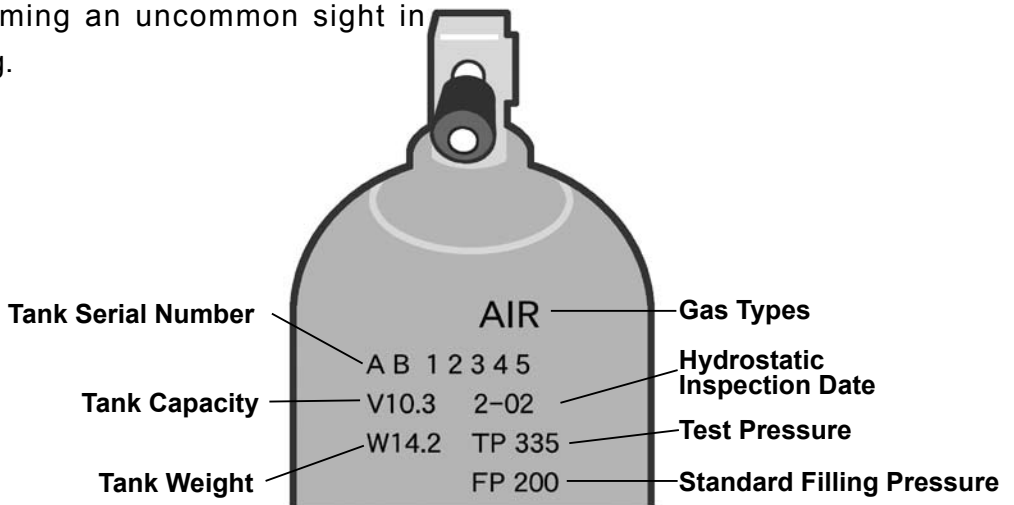
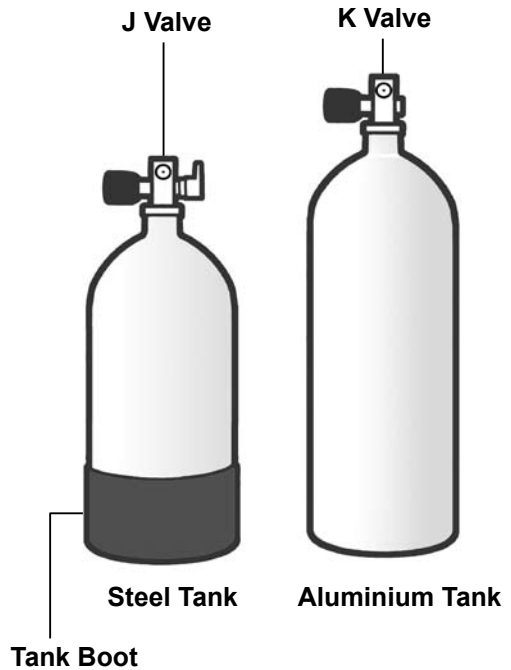

●●● Dive Equipment ●●●

Tanks have rounded bottoms, so tank boots are used. In Japan, SCUBA tanks must be the colour grey by regulation. This colour varies internationally.

To prevent corrosion from moisture entering the tank, it is important to leave a reserve of 30 bar or so in your tank.

To prevent any accidents, it is best to lay tanks flat in a cool area when not in use.

Steel tanks are heavier than aluminium tanks, so it is important to adjust your weights according to the type of tank used.

Because tanks left in hot sun are an explosion risk, please place in the shade.

Cover with towels or sheets. Do not leave tanks exposed in the sun.

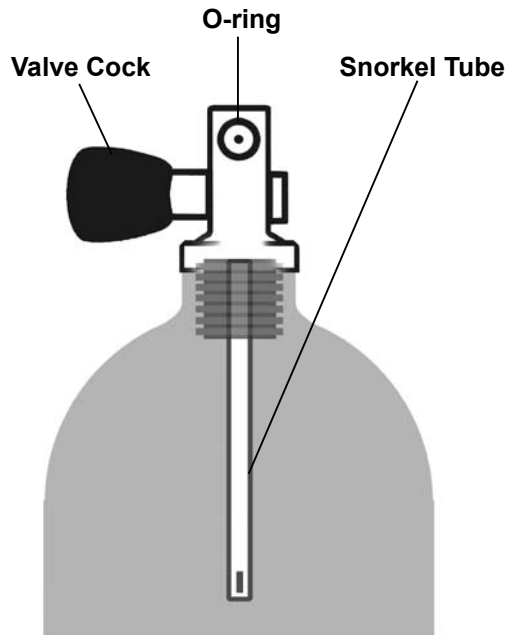

Tank Valve



Do not leave tanks exposed in the sun.

Regulator

A regulator converts the high pressure air in the SCUBA air tank to a level at which we can normally breathe. Working in conjunction with each other, the first stage lowers the pressure to about 10 bar whereupon the second stage further lowers the pressure to a comfortable breathing level.

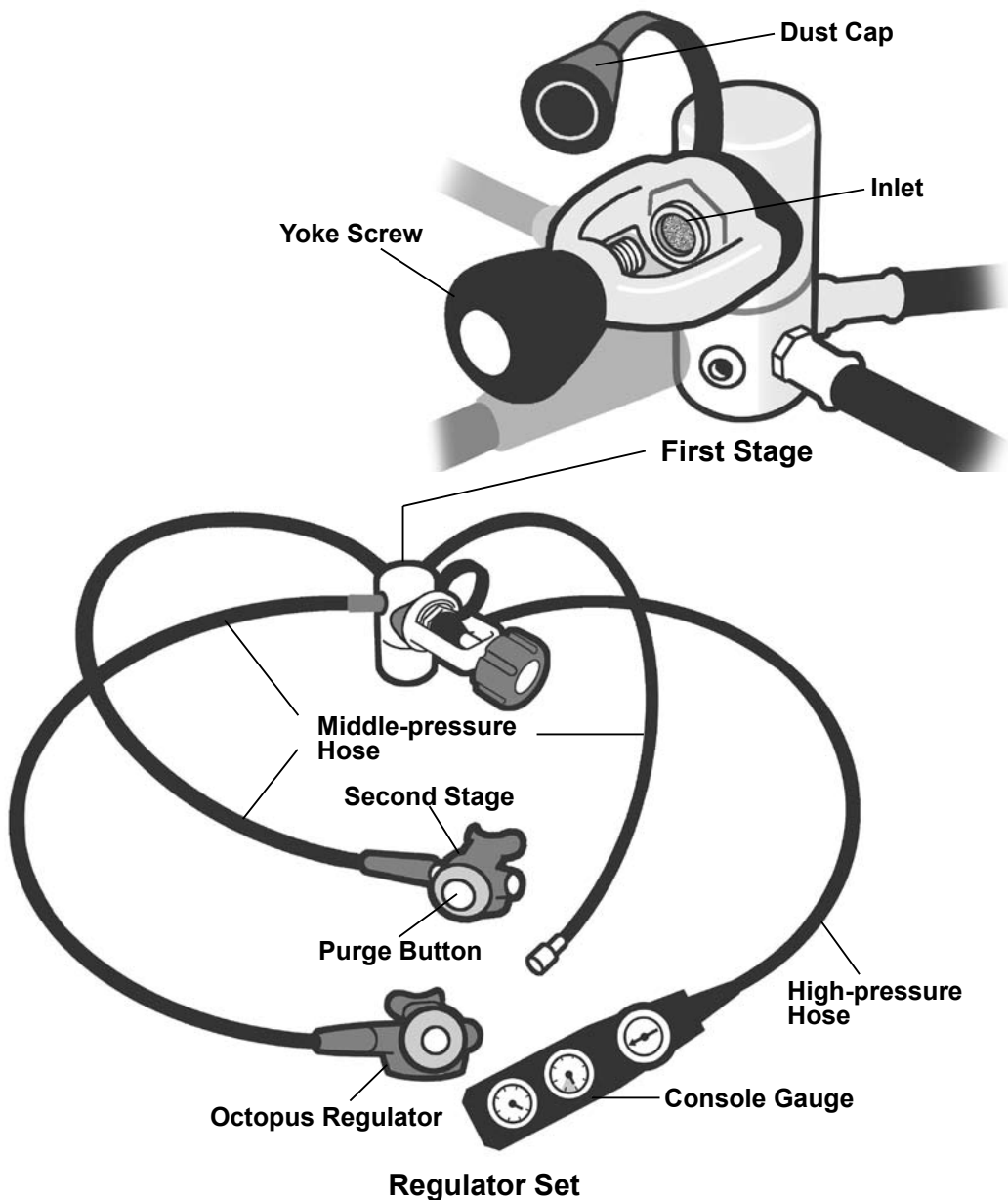

Backup SCUBA

If, by chance, you or your dive buddy run out of air, or your main regulator malfunctions, in order to safely return to the surface, backup SCUBA is the equipment we rely on.



Octopus Regulator

Safety Seconds

Two types of safety seconds are used: octopus regulator-type and octopus-inflator-type. The octopus regulator uses a middle-pressure hose longer than that used for the main regulator with a backup second stage regulator attached. The octopus inflator employs a second stage on the BC's inflator hose.



Octopus Inflator

Pony Bottle

A pony bottle is a smaller capacity tank with regulator attached. While filled with a backup supply of air, due to its limited size, it is usually appropriate only for a safe ascent and/or safety stop, and not for continuing a dive.



Pony Bottle

BC

By putting air into our BC from our tank, we can use the volume of air to control our buoyancy. In times of emergency, resting at the water's surface, or when moving, divers can ensure their buoyancy. Further, by careful use of air in our BC, we can achieve neutral buoyancy when underwater. The BC's harness on the back holds the tank in place.

There are jacket-type and back mount-type BCs. The jacket BC has two variations: the first, by way of adjustable shoulder/chest straps, allows us to fine-tune donning and taking off the BC, whereas the second is a fixed vest shape.

There are two methods to inflating your BC: the first is to push the power inflator's inflation button; the second is to orally inflate by blowing into the inflator's exhaust while pressing the inflator's exhaust button.

To avoid over-inflation, there is at least one relief valve built in to most BCs that will automatically release excess air. Although uncommon, there are some inflator hoses that, when pulled, release air.



Jacket-type



Shoulder Strap-type



Back Mount-type

●●● Dive Equipment ●●●

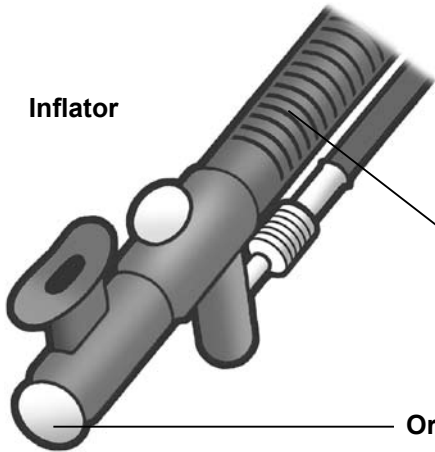
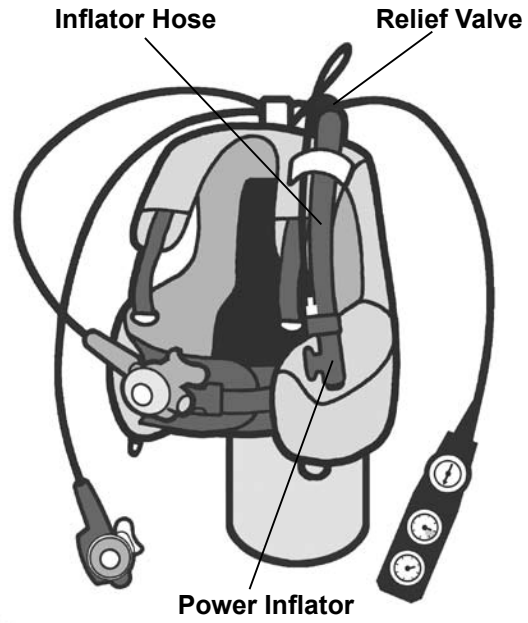
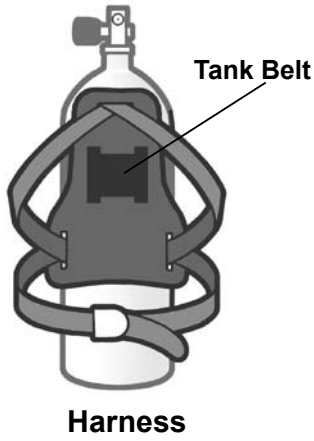

Inflator Hose

Oral Inflation Button

Power Exhaust Button
-included Inflator

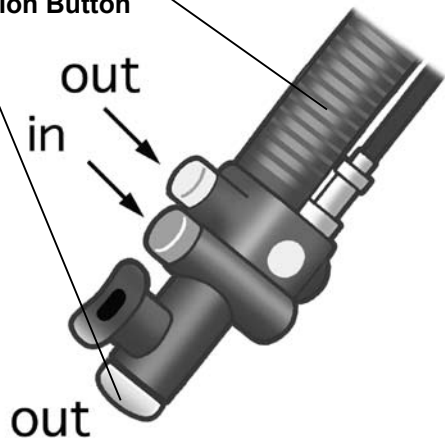
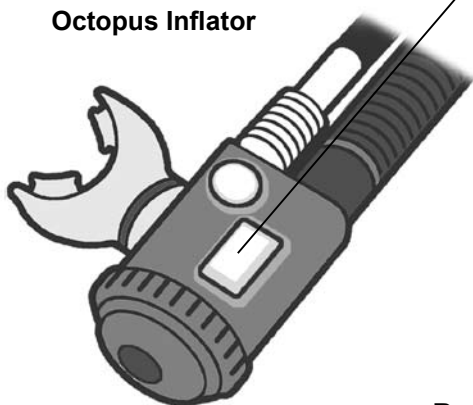

Power Inflator Types

Gauges

For safe diving, tank air pressure, water depth, dive time and direction are indicated by various gauges.

[Pressure Gauge]

We use a pressure gauge to see the remaining tank air pressure. Whether digital or analog, markings are made with luminescent paint or backlit to ensure viewability in any condition.

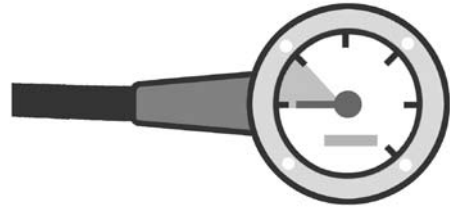

Pressure Gauge

[Depth Gauge]

Displaying current and maximum depths, there are digital and analog versions. Digital versions provide more data for dive logs.

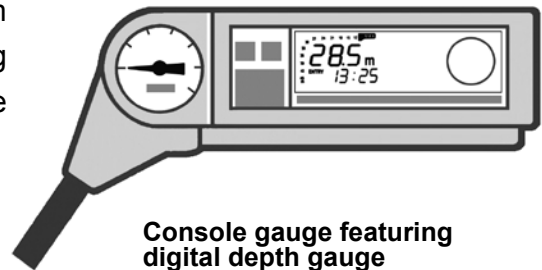

Console gauge featuring digital depth gauge

[Compass]

Used for direction taking and underwater navigation, diving compasses are pressure-resistant and waterproof, and come with bezel or lubber line.



Console gauge featuring compass

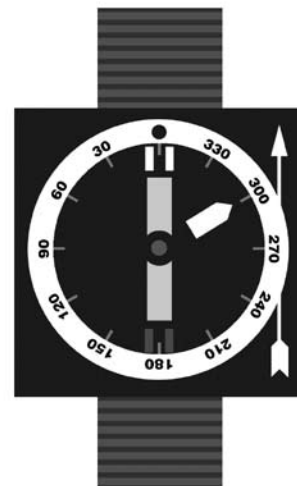

Compass

●●● Dive Equipment ●●●

[Dive Computer]

By providing many types of information, such as water depth and dive time, as well as a log function, dive computers are an indispensable item of dive equipment.



[Emergency Items]

If, by chance, you should find yourself adrift, items that help get you noticed include a large, sausage-shaped inflatable float and noise-making horns and whistles. There are also surface marker dyes and signal mirrors.

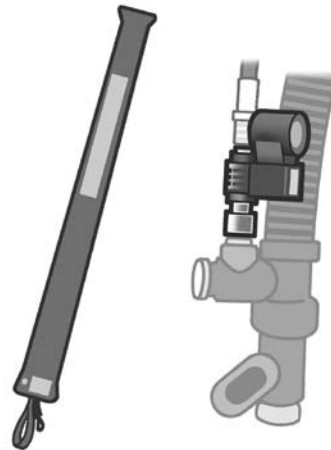

inflatable float noise-making horns

[Knife]

There are knives made from stainless steel and the more rust resistant titanium. In case of becoming caught in netting or ropes, we use knives to free ourselves of obstacles. Also, by striking the side of our tank with the knife, we can signal underwater. Finally, in case of a strong current, we can use the knife to anchor us into the surrounding seascape.

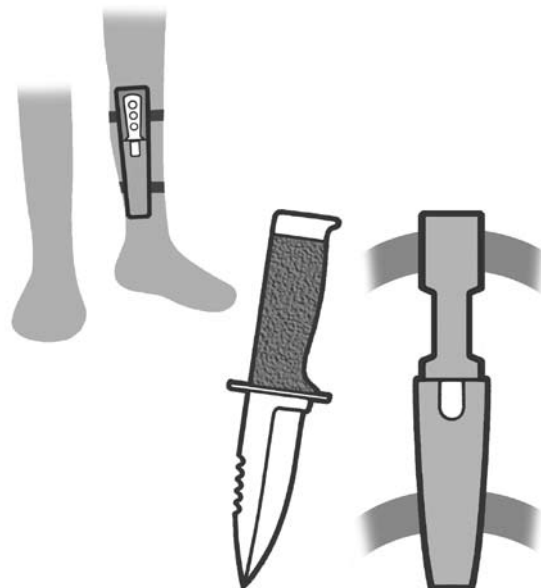

[Light]

Even in daylight, at depth the color red diminishes and appears bluish. In this case, by using a light, we can correct to true colors. Indispensable for night diving, it's a good idea to bring a light with you for daytime dives as well.

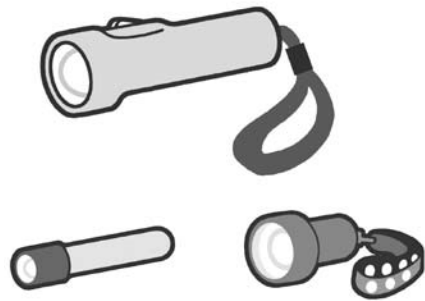

[Diver's Watch]

Dive watches are watches reinforced to resist water pressure and made waterproof to various depths. Analog-types, with uni-directional bezels, make viewing elapsed time easy. Digital-types, with depth meters, log book and other functions, are also widely available.



[Underwater Slates and Notepads]

Slates or notepads are used underwater, and are made of waterproof paper or plastic. They allow for us to communicate underwater when speaking is obviously impossible and gestures are limited, especially for detailed information.

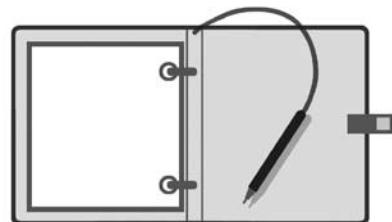

●●● Dive Equipment ●●●

[Log Book]

We use the log book to record our number of dives, dive time, air usage, water temperature, and so on, as well as our personal experiences, all in journal form. Required at resorts and such when diving as proof of experience, please make sure to maintain your log book. Many people personalize their books with illustrations and stickers - your enjoyment is Ok!

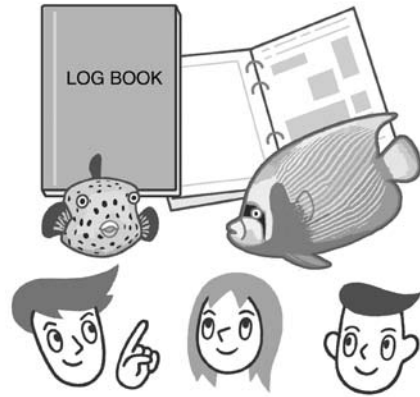

[First Aid Kit]

Most instructors and dive shops keep a typical first aid kit prepared, but since moist skin injures more easily than normal, it is useful to have antiseptic, bandaging, and such ready for use. It is also important to include all necessary emergency contact numbers.



[Spare Kit and Tools]

Items such as mouthpieces, mask and fin straps, and o-rings - all usually rubber or silicone-based - can tear, so it is a good idea to bring spares along with basic repair tools.

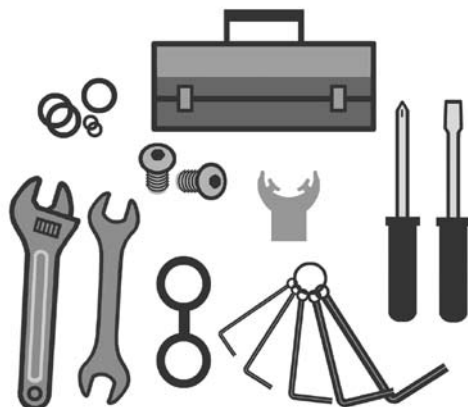

[Dive Flag]

Flags are displayed to indicate that “divers are below”. The red and white American style and, when diving from a boat, the blue and white international ‘A’ style are the two flags used.



American Style



International ‘A’ Flag

[Gear Bag]

Since there is so much gear to transport in diving, a gear bag is necessary. Mesh-bottomed bags have mesh material allowing drainage, and so are useful going to and from the beach or boat. Duffle bags, caster bags and hard cases don’t allow water to leak out, and so are useful for transport. Bags that have separate areas for gear and clothing are very useful.

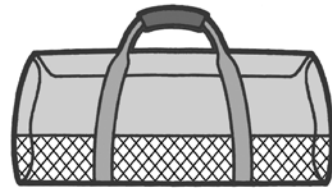

Mesh Bag

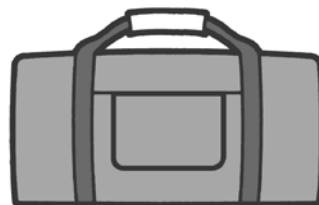

Duffle Bag



Caster Bag

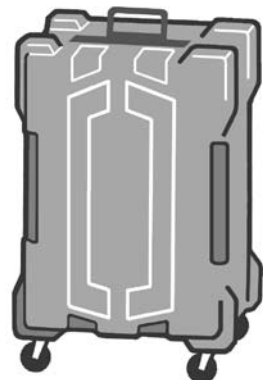

Hard Case with Casters

Gear Preparation

New masks have a protective oil film on the lenses that, if left on, cause masks to fog. It is important to wash with a non-abrasive detergent before use.

In the same way, you should wash new fins and snorkels as well.

To avoid confusion over gear ownership, you should mark your gear with your name or easily identifiable mark.

Next, you should adjust all straps for the best fit possible.

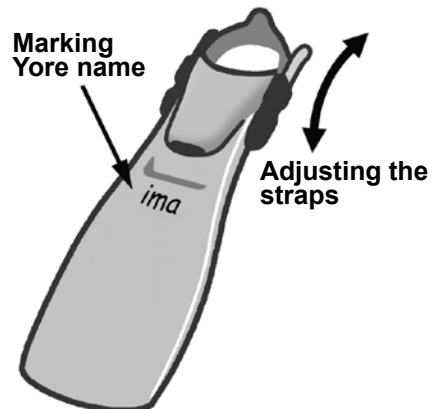

Equipment Maintenance

After being used in the ocean (salt water) environment, it is important to wash equipment with clean water and dry in the shade.

Hang your diving suit on a dedicated hanger to prevent creasing or folding.

If you wash your regulator without the dust cap tightened, water can enter and cause corrosion.

As well, you should not push the purge button when you wash your regulator.

It should be overhauled every year by a professional. Do not take it apart by yourself.



To protect your equipment, transport in a hard case.

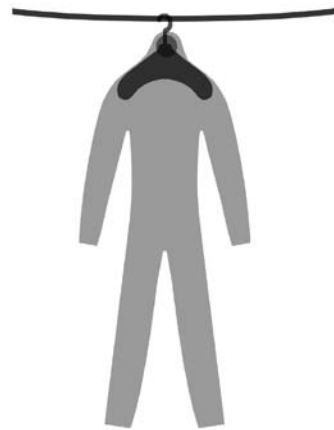

Hang your diving suit on a dedicated hanger to prevent creasing or folding.



Should be overhauled every year by a professional.

The Underwater Environment

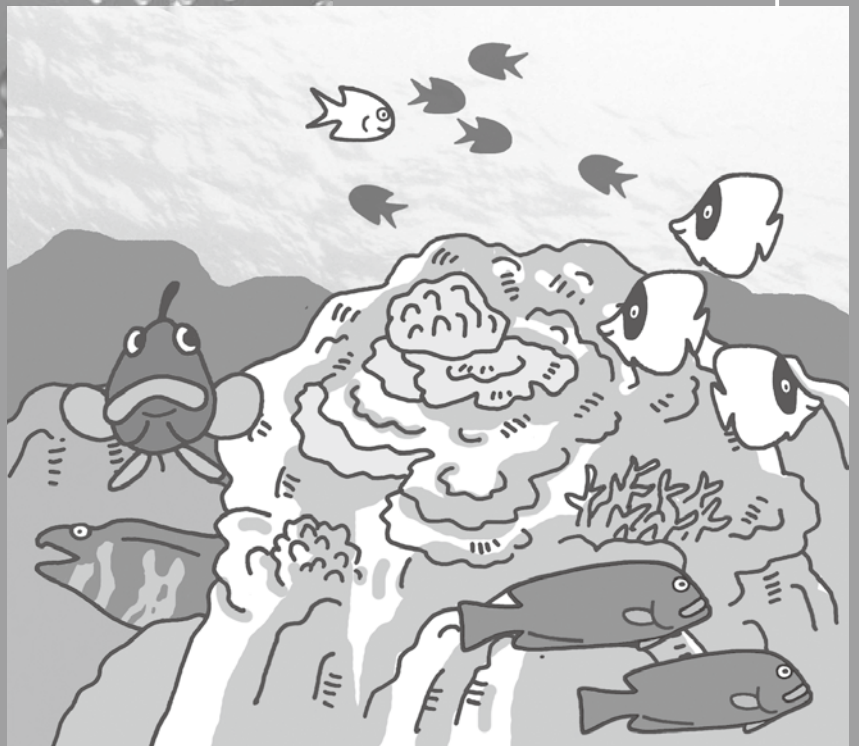
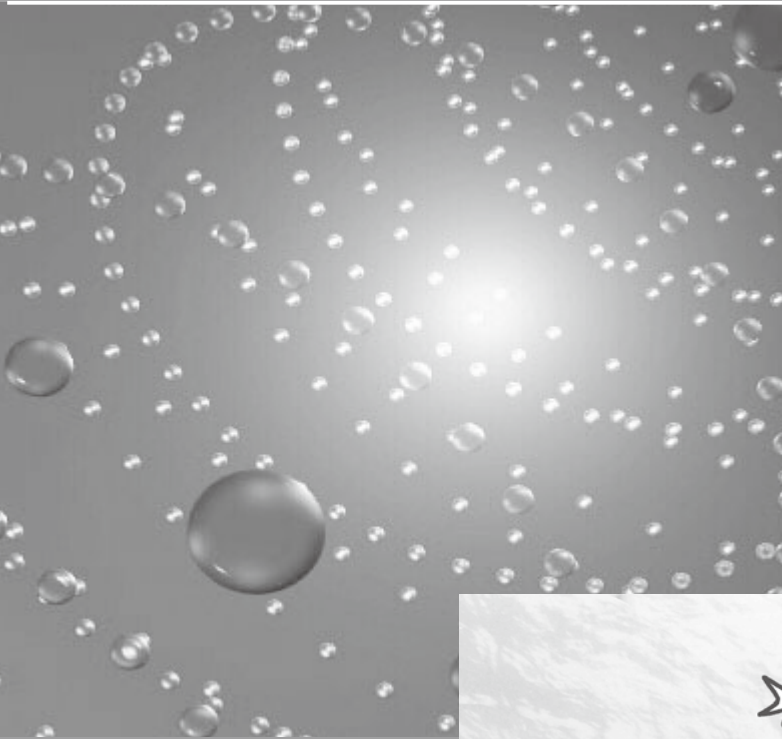

●●●Underwater Environment●●●

Just like we find rivers and mountains on land, we also find rivers and mountains underwater. After learning about the underwater environment, let's visit the underwater world. It is in the underwater world where we can expect to be greatly moved.



Topography and Artificial Structures

Similar to on shore, on the bottom of the ocean we find various topography and artificial structures. While these features are enjoyable in themselves, observing the various sea life which lives there is one of the best activities in diving.

[Artificial Reefs]

These are man-made structures placed on the bottom of the ocean for the dwelling of sea life. Not only made for fish, many varieties of sea creatures reside here.



[Large, Worn, Rounded Rocks]

These are rocks that have been worn round through the ages, and continue to be shaped and moved by the sea. Fish and shrimp hide in the spaces in between and at the backs of these rocks.



[Sand Areas]

Due to sea swell, in the sand parallel to the coastline occur ripples that resemble tiny mountains. Left-eye and right-eye flounders, altering their body color to match that of the surrounding sand, are able to conceal themselves here with ease.

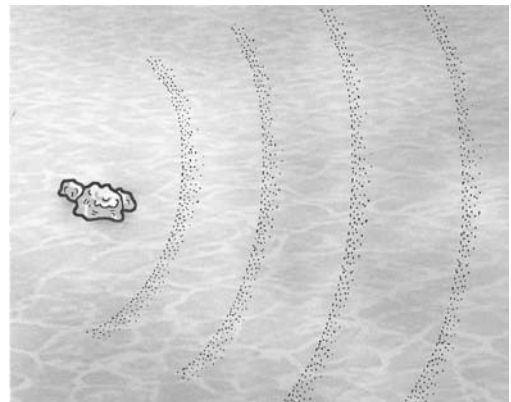

●●●Underwater Environment●●●

[Sunken Wrecks]

Due to accident or war, sunken ships host a large variety of sea life. Specialized training is required for penetration of wreck interiors.



[Drop-offs]

Drop-offs are sudden, vertical slopes found relatively near to shore. At drop-offs we find magnificent scenery and the open ocean's migratory fish.

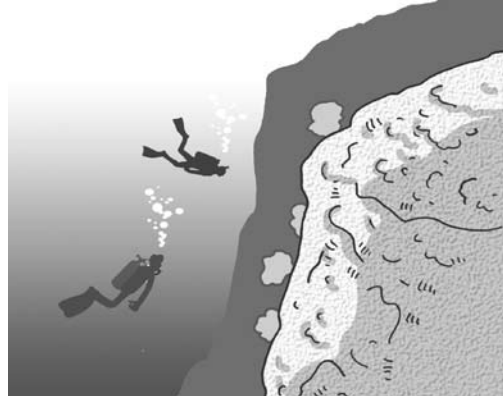

[Rocky Areas]

Among rocky areas, those large clusters of large rocks or those resembling mountain ranges are referred to a grouping. When these groupings occur along the paths of migratory fish, many varieties of fish can be found feeding and cleaning.



[Coral Reefs]

Coral reefs are widely found in warm ocean areas. Crowded by colorful tropical fish, reefs are extremely popular dive spots. As coral growth is extremely slow, some formations take several tens or hundreds of years to develop. As a result, let's take great care when diving around coral reefs to prevent breakage or damage.

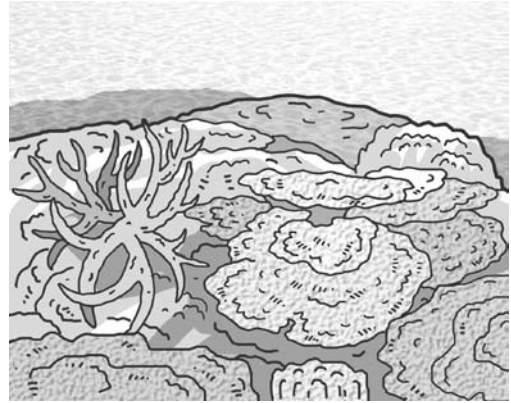

[Arches]

When diving in any of the volcanic belts around the world, we often find lava arches. The contrast of light is very beautiful.



[Caves]

In caves, we find spiny lobsters and other sea life that prefer to hide in dark locations. In these locations that dive light you've prepared will come in handy!

For penetration of any long caves, specialized training is required.

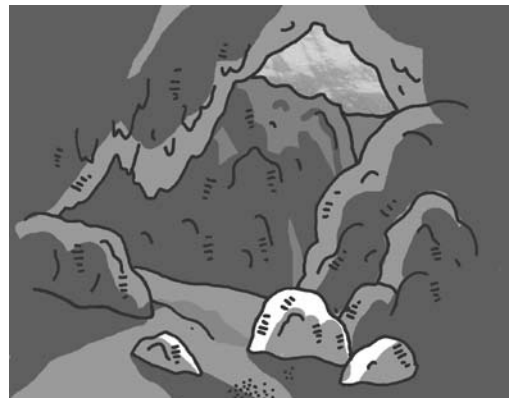

Ocean Conditions

Wind or ocean currents have a great influence over the waters in which we dive. When the surfing is good, the diving isn't. The most suitable conditions for diving are when there are no waves or current.

[Waves]

Waves have their origins primarily in wind, and while there may be no wind blowing near the coast, there may be winds blowing in the open sea which can cause high waves to break on the shore. If high waves break, the ocean bottom is stirred up, causing silt to blur visibility. As well, as waves approach the shore, they collapse, causing undertow and rip currents. In this region - the surf zone - it is easy to have your feet pulled out from under you, especially with all your equipment on, so caution is required.

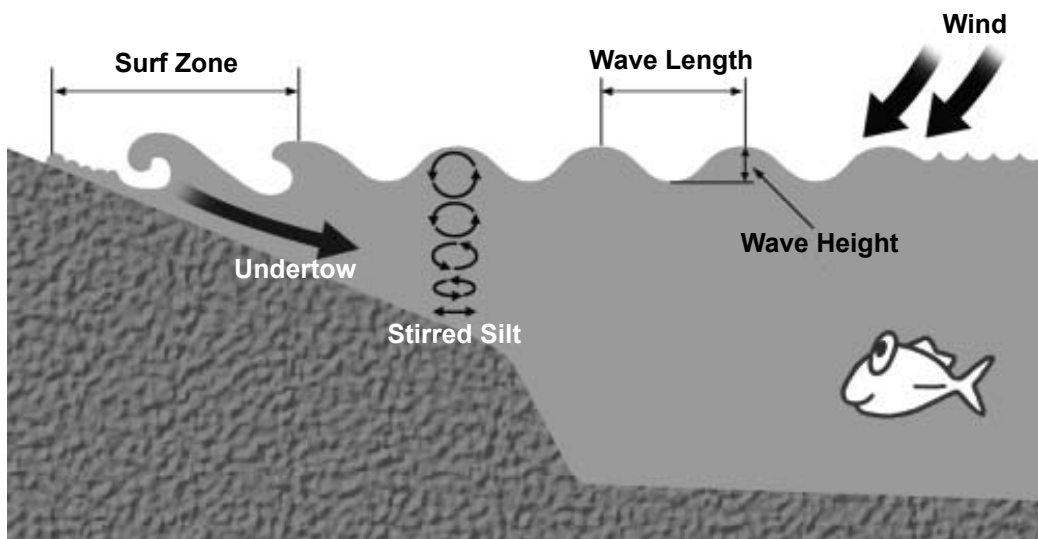

[Land Breezes and Ocean Breezes]

During the day, most breezes originate over the ocean. These daytime ocean breezes, affected by high pressure under the influence of the sun, are quickly warmed over the water's surface. The resulting rise of air causes the phenomenon. Conversely, in the evening, the land is cooler than the ocean, so breezes originate over land and blow towards the sea.

Ocean Breezes

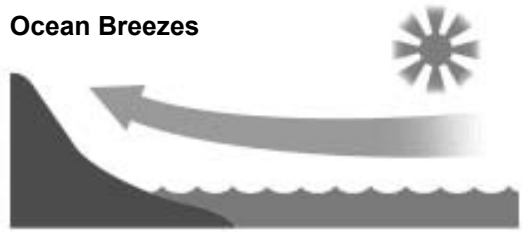

Land Breezes



[Topography and Ocean Currents]

Winds that follow lengthy, unbroken coastlines create long shore currents. So far as shallows exist near the shore, undertows are created, and at breaks in the shallows, strong rip currents are created. As well, where there are groupings of large rocks, complex water channels are created which require caution.

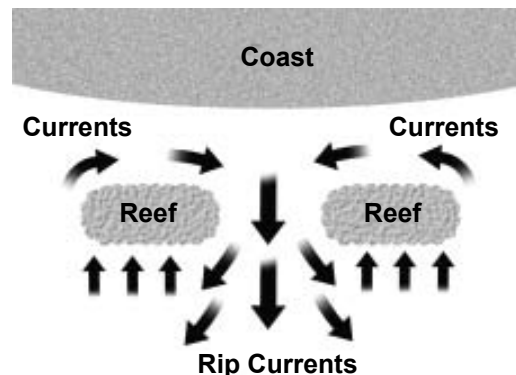
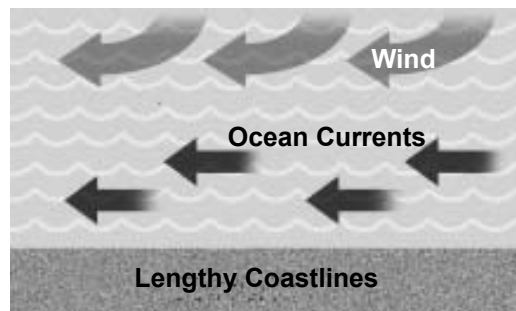

●●●Underwater Environment●●●

[Thermoclines]

Where warm and cold ocean water or where fresh water and salt water meet underwater, the scene seems to dim and flicker and vibrate - this is a thermocline.

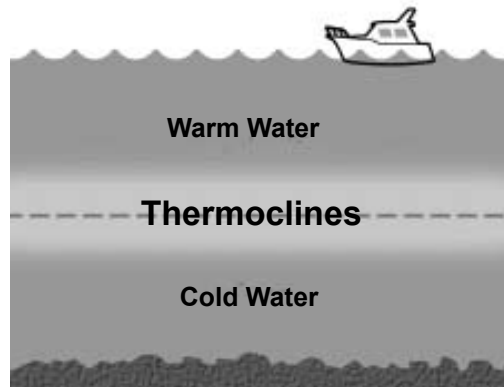

[Water Clarity and Visibility]

Underwater, plankton and other floating matter as well as silt stirred up from the ocean's bottom can worsen water clarity and visibility. When these are bad, both seeing around you and at a distance are difficult, so it is important not to become separated from your dive buddy. In the opposite case, when clarity and visibility are extremely good, depth perception is slightly off and you can easily overshoot your planned maximum depth, so caution is required here, too.

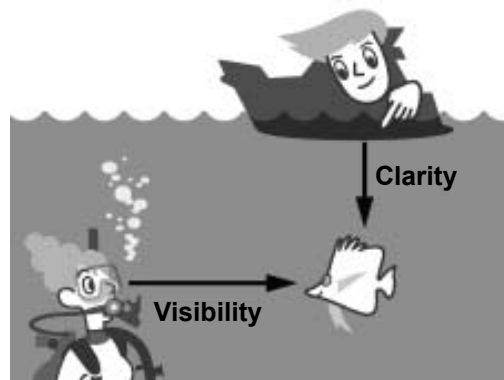

[Ocean Currents]

Ocean currents flow like rivers. These currents occur partly due to differences in water's density. Along Japan's Pacific Coast flow two main currents - the warm Black Current as well as the cold Kurile Current.

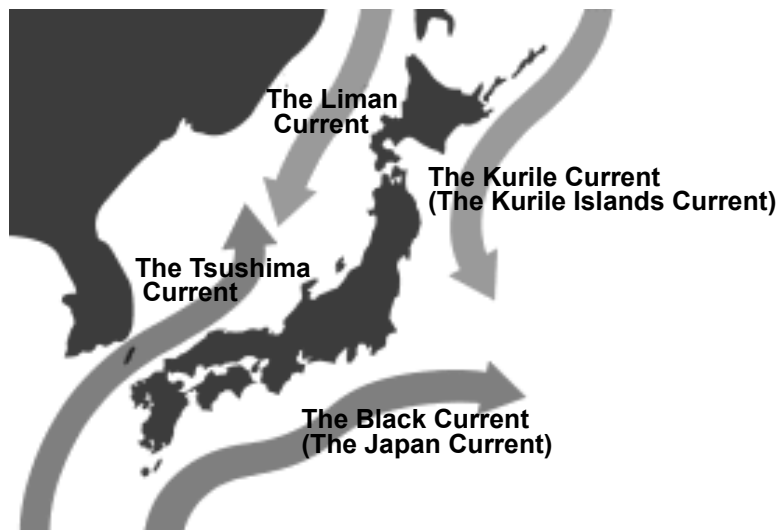

[Tide and Tidal Currents]

Due to the gravitational effects of the sun and moon on the earth, twice a day we have high and ebb tides. Tides, causing the ebb and flood of water levels, create tidal currents. Generally speaking, at new moon and full moon, tidal currents are strongest (spring tides), while neap (low) tides and long tides' tidal currents are weakest. When ebb and high tides are at their apex, the tidal current stops. The Japan Coast Guard publishes tide tables which you can employ in your dive planning.

Poisonous Sea Life

While being attacked by poisonous sea life is not a realistic concern, accidentally touching or being touched is a caution we should strive to remember. As well, if you are unsure about a sea creature, it is best not to touch it.

[Stingray]

Rays possess a poisonous needle in their tail. They often sit on the sandy bottom, so watch your step. Electric rays can deliver a mean shock.



[Wasp scorpionfish]

Nocturnal by nature, rockfish by day conceal themselves in the silt. Be careful of your foot placements, since these fish have poisonous spines along their back.



[Sea Catfish]

These fish have poisonous spines along their back. Young fry gather in large schools, and these fish live among rock groupings.



[Lionfish]

With beautiful, feather-like fins, this eye-catching fish's poisonous spines are dangerous.



[Devilfish/Stonefish]

These fish have poisonous spines along their back. Residing in rocky areas, they completely mimic their surroundings, so be careful when touching rocks.

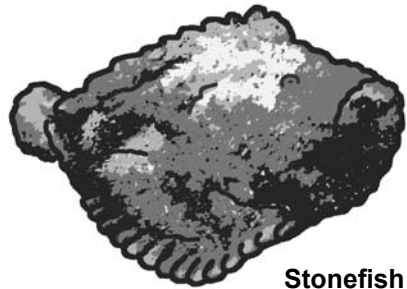

Stonefish

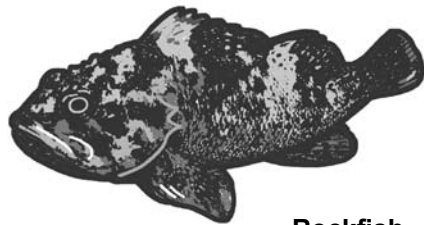

Rockfish

[Sea Snake]

With poison more potent than a cobra, these snakes live in warm waters and, as air breathers, can regularly be seen to surface for air before diving in search of prey.



●●●Underwater Environment●●●

[Octopus]

Octopi, particularly large ones, have such powerful suckers that they present the danger of freely manipulating and injuring a diver, such as taking hold of the diver's mask or regulator.

The tiny and beautiful blue-ringed octopus possesses a poison so toxic that one bite is deadly. However, these are not aggressive unless provoked.

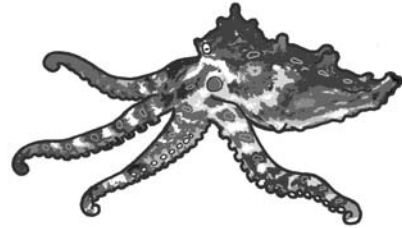

[Jellyfish]

Most jellyfish possess poisonous nematocysts in their tentacles. The Portuguese man-of-war and similar jellyfish are deadly.

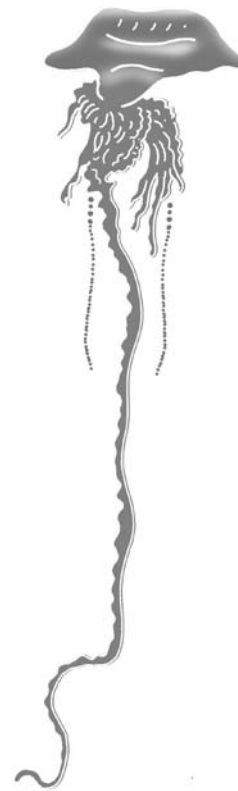

[Cone Shell]

The attractive and seemingly innocuous cone shell is has a powerful poisonous needle that darts out when disturbed, to deadly effect.

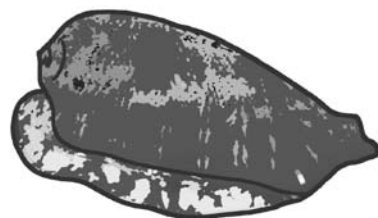

[Sea Urchin]

Diadem urchins (longspine urchins) and other sea urchin have poisonous spines which easily penetrate wetsuits and skin before breaking off to remain imbedded underneath the skin. Iijima Fukuro urchins and pacific urchins possess neurotoxins - keep clear!

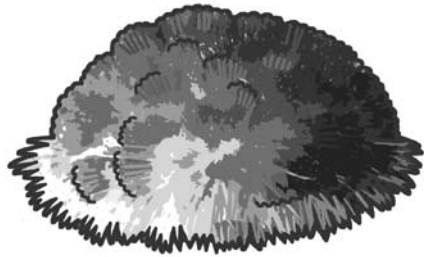
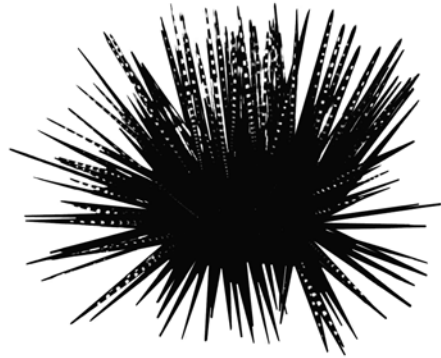

[Crown of Thorns Starfish]

Living on coral reefs, these starfish possess wide, pointed, poisonous thorns. Since they have had an explosive increase in population in recent years, these coral, coral crab and conch shell-eating pests are now targeted as a protective measure.

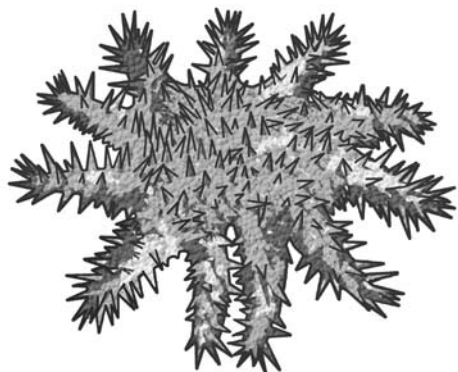

[Hydrozoan Stinging Ferns]

With branches resembling chicken feathers, these hydrozoans (in the same family as jellyfish) have nematocysts which, when brushed up against, fire. The result is a pricking pain, ache, red blisters and strong itchiness lasting several days.



[Fire Coral]

Very similar to regular coral reef, these are widely distributed among tropical reefs. If accidentally touched, these produce a burning pain and inflammation that lasts for several days.



Aggressive Sea Life

Aggressive sea life use aggression as a defensive instinct. So if they are not provoked, risks are minimal.

[Barracuda]

To some extent, juvenile barracuda prefer to school together, but upon reaching adulthood, hunt solely. The barracuda's sharp teeth are dangerous.

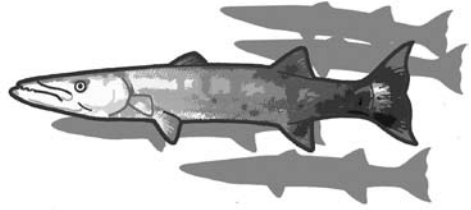

[Shark]

Most sharks are stimulated by the smell of blood and splashing. If an aggressive shark appears, it is best to remain calm and still against the ocean bottom or reef. Panic and rapid movements will only provoke an aggressive shark.

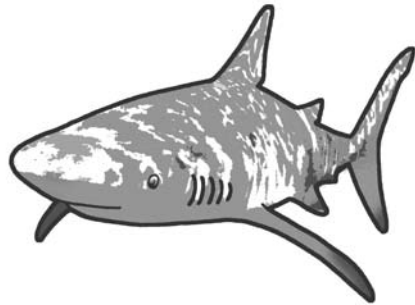

[Moray Eel]

Eels turn up at holes in coral and rocks. If feeding an eel bait, there have been cases of the eel mistaking a finger for the bait. As well, teasing an eel can only lead to an unpleasant result.

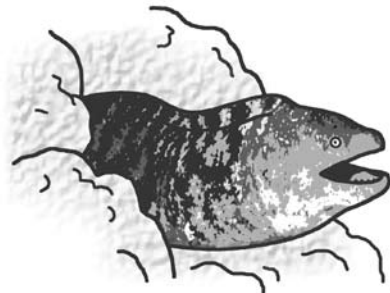

●●●Underwater Environment●●●

[Needlefish/Garfish]

Needlefish have long mouths with sharp teeth, and stay near the water's surface. Attracted to light, they have rushed divers during night dives. As a result, when night diving, you should not hold your light on the horizontal, but rather point it down below.



[Triggerfish]

Residing in warm climates, when spawning, triggerfish will repeatedly attack humans approaching their territory. Their teeth are conditioned to chewing coral for feeding, so they are very sharp indeed.

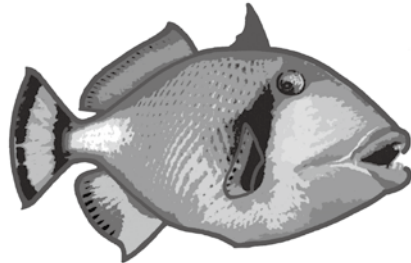

Underwater Physiology

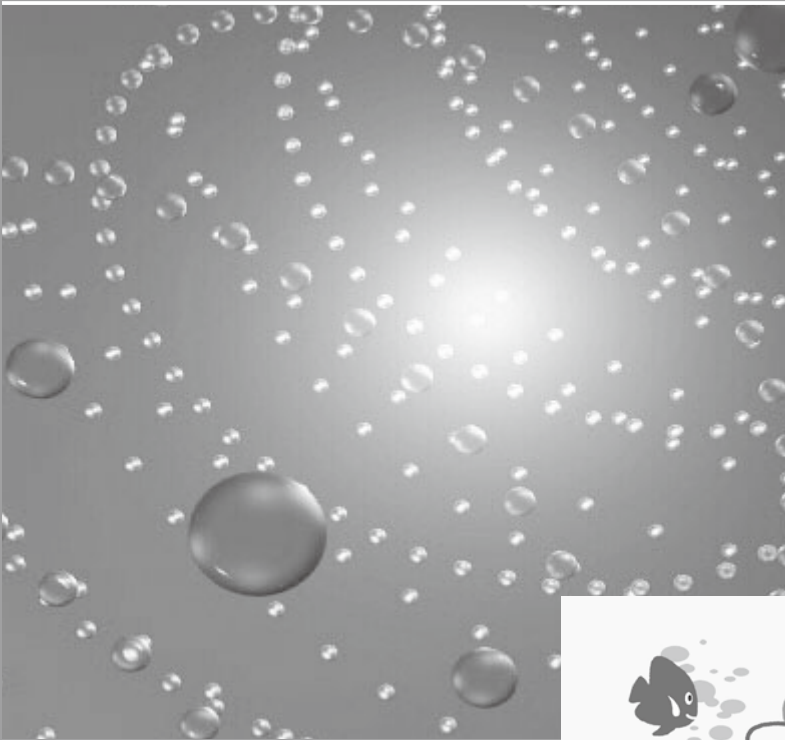

●●● Underwater Physiology ●●●

In the underwater world, the sensation of water and water pressure is quite different from that of being on land. This is due to water and water pressure having a great influence on our bodies. In order to dive safely we need to understand what effects these phenomena have on us.



Light and Color

Underwater, things like fish appear 1 and 1/3 times larger and - times closer due to light refraction as light enters the mask. As a result, when reaching out for something like a rope which will appear larger and closer than it really is, you should be careful not to misjudge distances.

As well, the deeper the water, the more light is absorbed, so first red, then orange, yellow, green, and finally, blue become more drab and hard to distinguish. However, use of a dive light will bring to light all the stunning colors of the ocean.

Light Extinction Coefficient

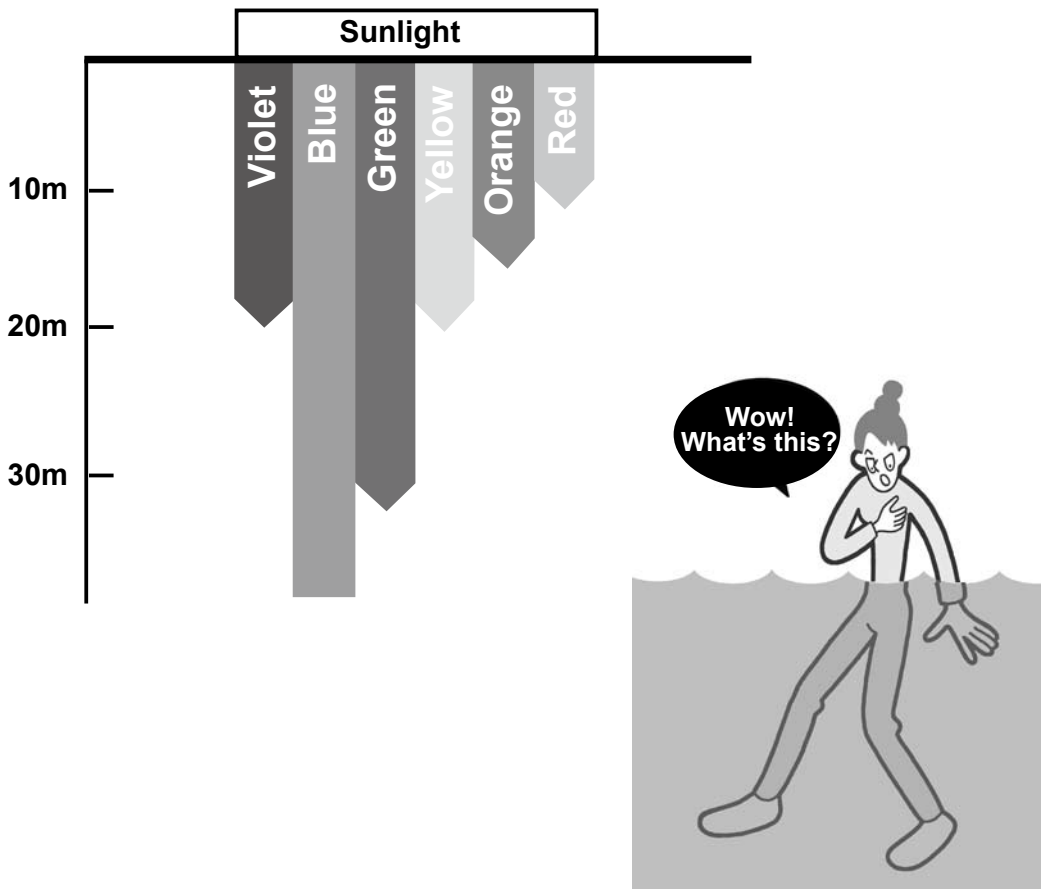

Sound

Sound waves travel 4 times faster underwater than in air. Due to the speed of sound underwater and how there may be directional variances (right ear versus left), we need to heed caution when deciding on the point of origin of sounds. You should visually confirm your environs, especially concerning tank knocking signals or the sound of boats passing by overhead.

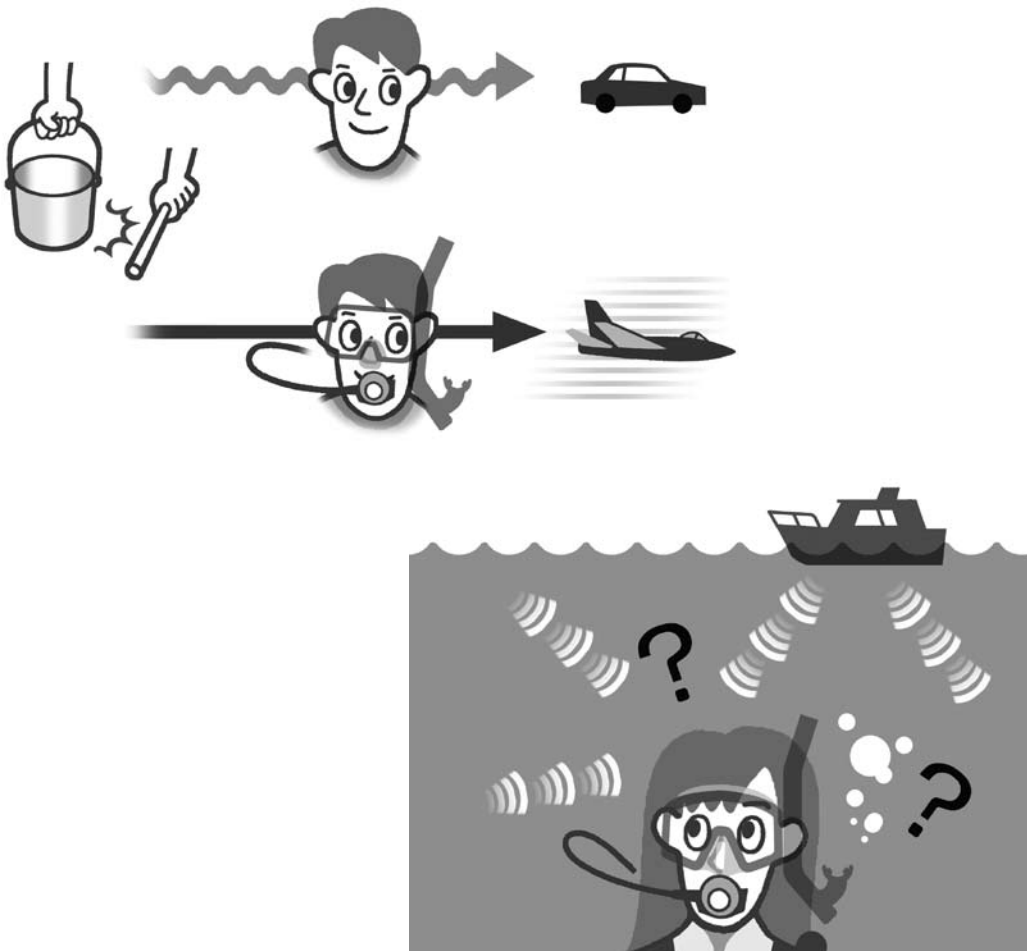

Drag

To swim in a vertical position creates a large amount of drag, which makes swimming forward all the more difficult. This is due to the fact that water density is 800 times greater than that of air. As a result, you should strive to swim in a horizontal position.

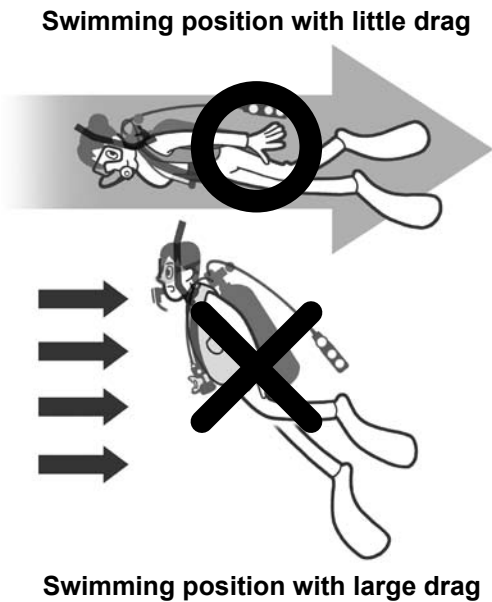

Buoyancy

We say positive buoyancy creates floating, negative buoyancy creates sinking, and neutral buoyancy creates static positioning (neither floating nor sinking) in water. Wetsuits and adding air to our BCs create positive buoyancy. In our lungs, inhalation and exhalation of a typical air capacity of 2 - 4L equals 2 - 4kg of buoyancy we can control.

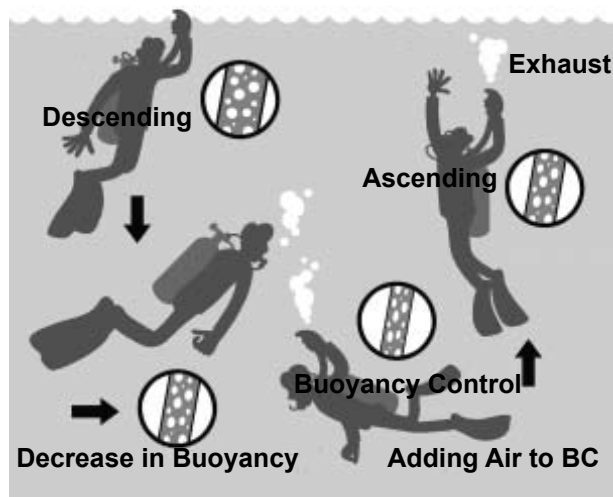

Heat Absorption

Heat is absorbed 3,000 times faster in water than in air. This is why, to prevent heat loss when diving, we wear wetsuits and such appropriate to the water temperature.

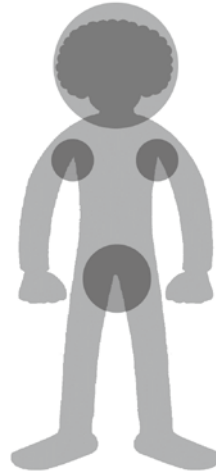

Key Heat Loss Spots

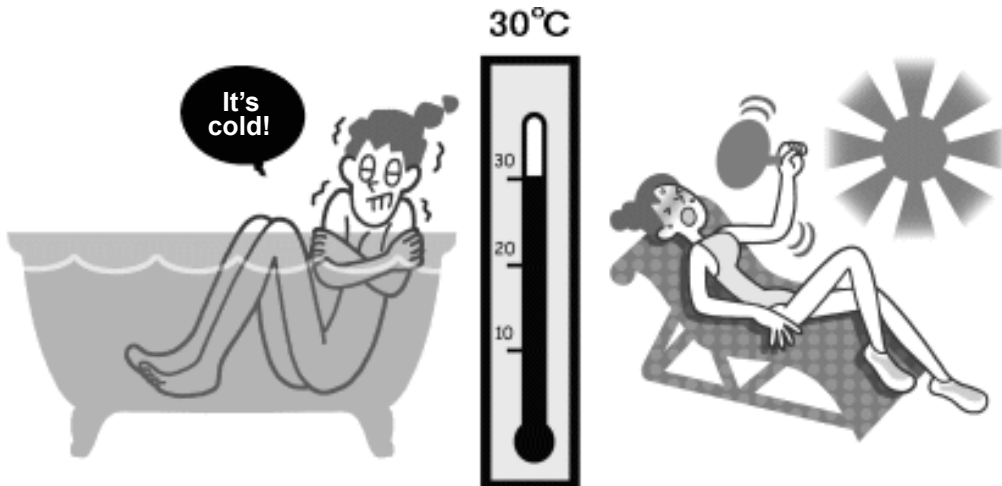

Bath

Ah - warm

Air Composition

In the air we usually breathe, Oxygen makes up 21%, Nitrogen makes up 78% and other gases makes up 1%.

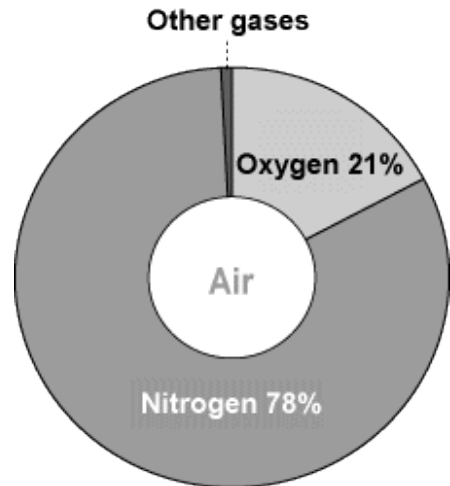

Breathing and Circulation Mechanism

As the mouth and nose connect to the trachea, the trachea continues to the bronchial tubes where, in turn, we find the uncountable alveoli. With a surface area roughly equivalent to - of a tennis court, the alveoli capillaries are extensive. It is in the alveoli that the gas exchange of oxygen and carbon dioxide occurs. As the concentration of carbon dioxide increases, the brain's respiratory centre stimulates the next breath.

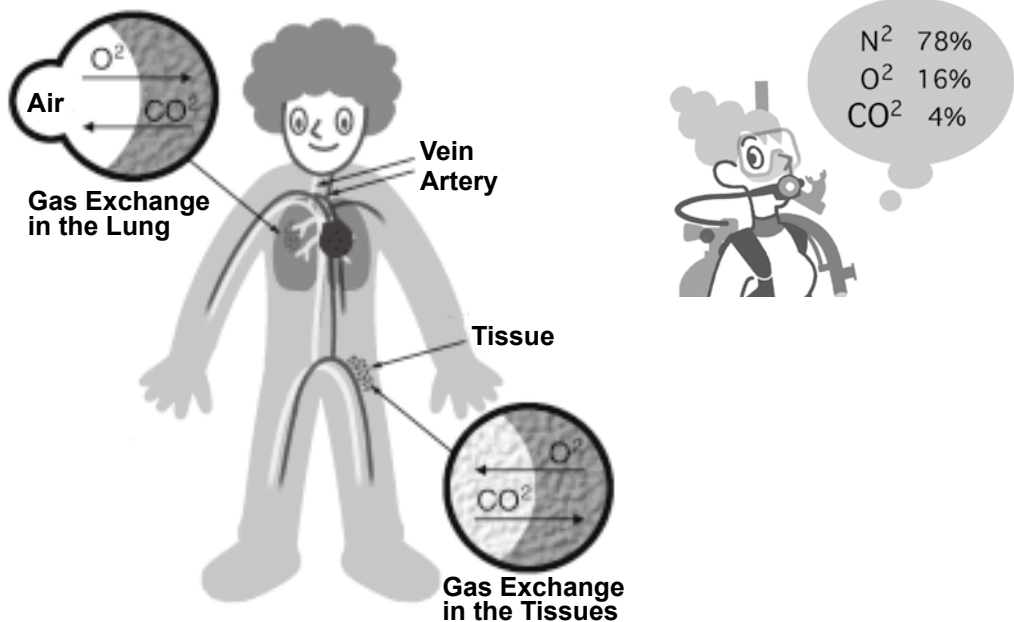

Gas Exchange Process

Divers Breathing

Underwater, the compression of water under the density of air causes increased breathing resistance. As well, the dead space in the regulator increases, requiring adequate ventilation. That is why it is best to breathe slow, large breaths. Thus, we focus on good, sufficient breathing techniques when diving.

Air Consumption

When exercising and when tense, our breathing rate increases. Rather than swimming at full speed, when diving it is important we swim in a slow and relaxed way. As well, when compared to smaller people, larger people use more air so air consumption monitoring is very important.

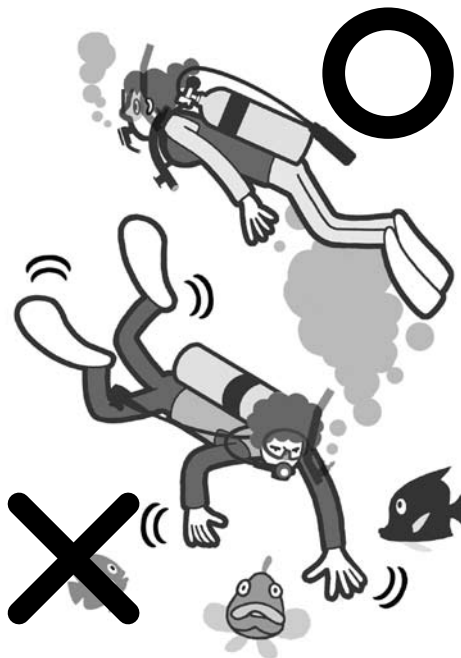

We swim in a slow and relaxed way.

Pressure

Pressure equals weight per unit of area. On land, we are at an atmospheric pressure of 1 bar, but this increases the deeper we go underwater. For every 10m of depth, atmospheric pressure increases by one. As freshwater is slightly less dense than salt water, the ratio is 10.3m to 1 atmosphere.

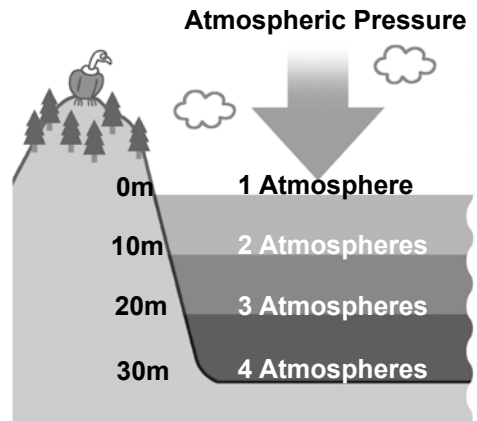

Pressure and Water Depth

We calculate pressure the following way:

$$\text{Pressure} = \text{pressure depth} \div 10 + 1$$

Pressure and Gas Volume

If we take an inflated balloon and sink it underwater, due to water pressure its size will decrease, but upon returning to the surface it will increase again to its previous size. This is due to gas compression. Pressure and volume are inversely proportional: For example, if pressure is double, volume is 1/2. If pressure is 1/2, volume is double.

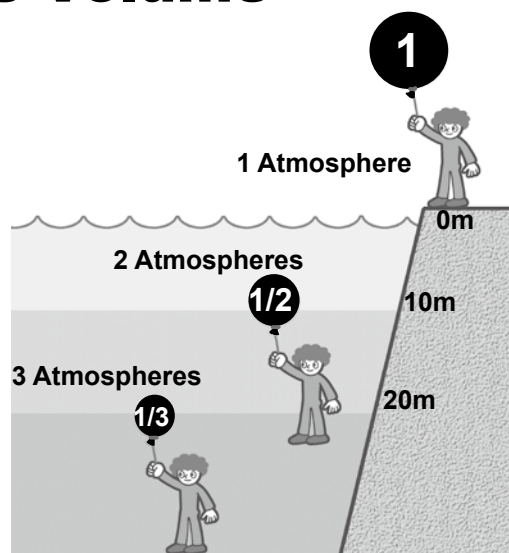

Water Depth and Gas Volume

Lung Over-expansion Injury

If, when diving, you were to surface while holding your breath, the air in your lungs would cause your lungs to over-expand, requiring medical treatment. The leaking of air from between your lungs and pleura is the cause of chest pressure and pain in this case. Symptoms include pressure on the heart and blood vessels, breathing difficulties, and loss of consciousness.



Air Embolism

In the case of ruptured alveoli, air directly entering the blood vessels can cause blood flow to stop, which is a very dangerous medical condition, to say the least. The more common cerebral vascular embolization's symptoms include dizziness, mental affect, paralysis, coma, leading to death in the worst case. These symptoms are very quick to develop upon surfacing from a dive. So, if an air embolism is suspected, oxygen and other first aid, followed by immediate transport to a hospital, are necessary. In the hospital's recompression chamber (a small, pressurized room or tank), the diver is recompressed to a greater pressure to reduce the size of the air bubbles in the body.

The key point is never to surface while holding your breath.

Make sure to develop a pattern of always regularly breathing underwater.

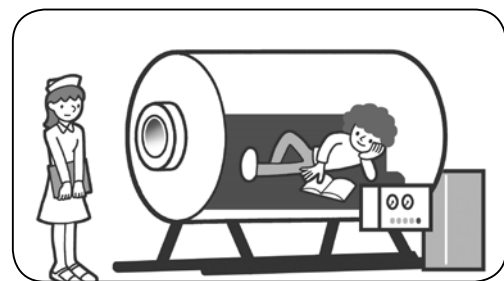
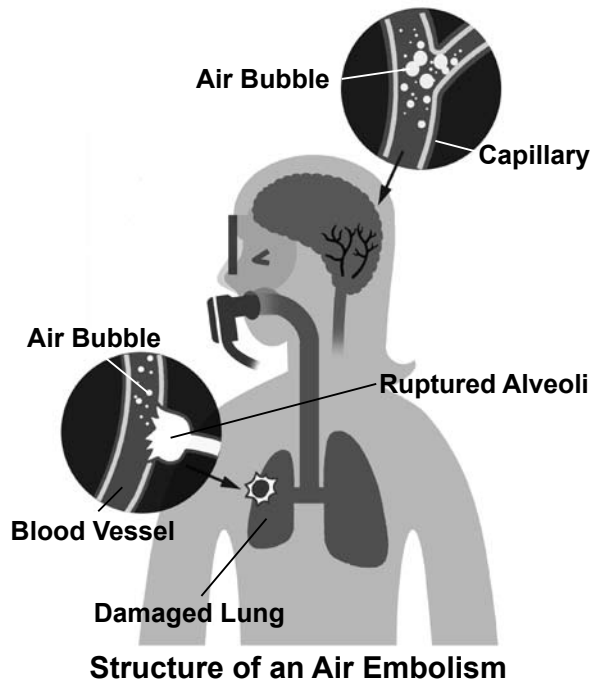

Gas Poisoning

Since air pressure is greater underwater than on land, various gas mixtures' effects on a diver can be great.

[Oxygen Toxicity]

When oxygen is breathed under high pressure, oxygen toxicity can occur. Lip trembling, convulsions, and nausea are common symptoms; coma can occur. As a result, oxygen-only tanks are never used. Even tanks filled with the normal mixture of air present a risk of oxygen toxicity at depths greater than 70m, where special mixes are required.

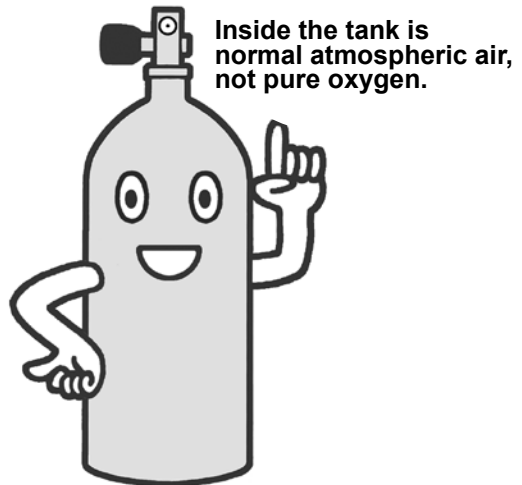

[Carbon Monoxide]

Carbon monoxide is poisonous, so at high pressure even a small amount can be toxic. Symptoms include headache, confusion, narrowing of the visual field, and translucence of the lips and nail beds. Although carbon monoxide is hard to detect as it is odorless and colorless, if, when doing your pre-dive check, you notice any smell or effect from the tank's air supply, you should exchange tanks.



●●● Underwater Physiology ●●●

[Nitrogen Narcosis]

At depths greater than 25m a feeling of intoxication can occur. This intoxication, called nitrogen narcosis, is dangerous because it has an effect of anesthesia. While the effects vary from none to great from person to person, the inability to think safely is a risk. If nitrogen narcosis is suspected, please return to a shallower depth as this will quickly resolve any symptoms.

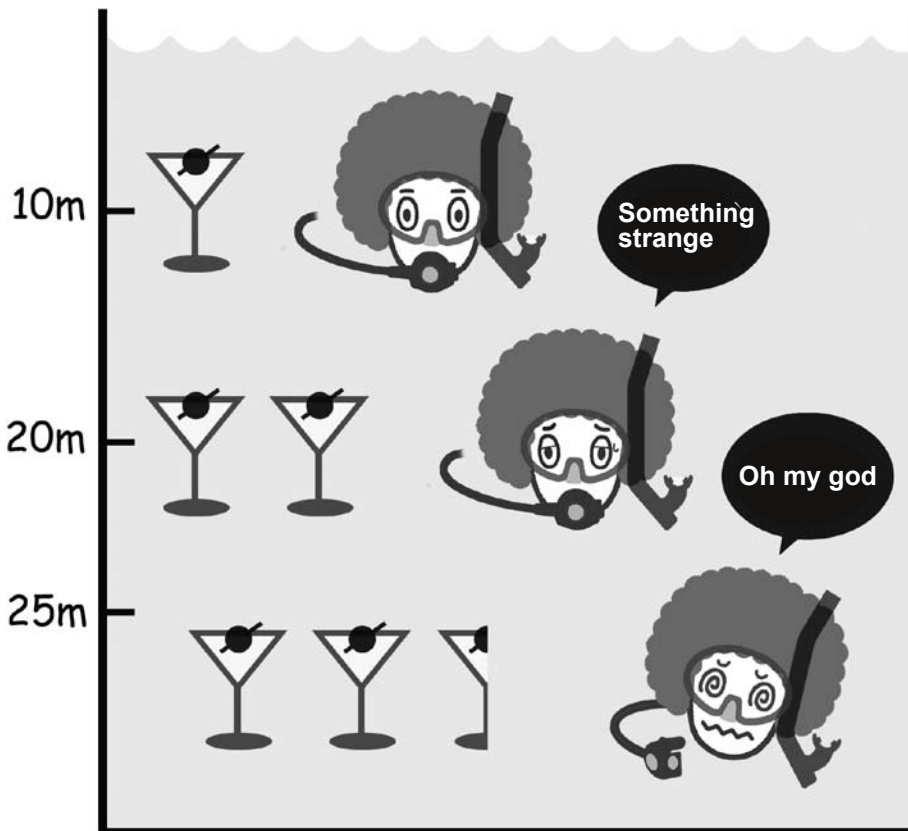

The law of martini

Hyperventilation

A breathing technique for snorkeling in which you quickly and deeply breath a few times to lower the concentration of carbon dioxide in your body, hyperventilation allows you to breath hold for a longer than usual period of time. However, when done to excess, the lowered concentration of carbon dioxide fails to stimulate the breath response in the respiratory centre, causing a loss of consciousness due to lack of oxygen. Often occurring on or near the water's surface, the term "Shallow Water Blackout" is used. As a loss of consciousness in water is clearly dangerous, never hyperventilate to excess.



Hyperventilation

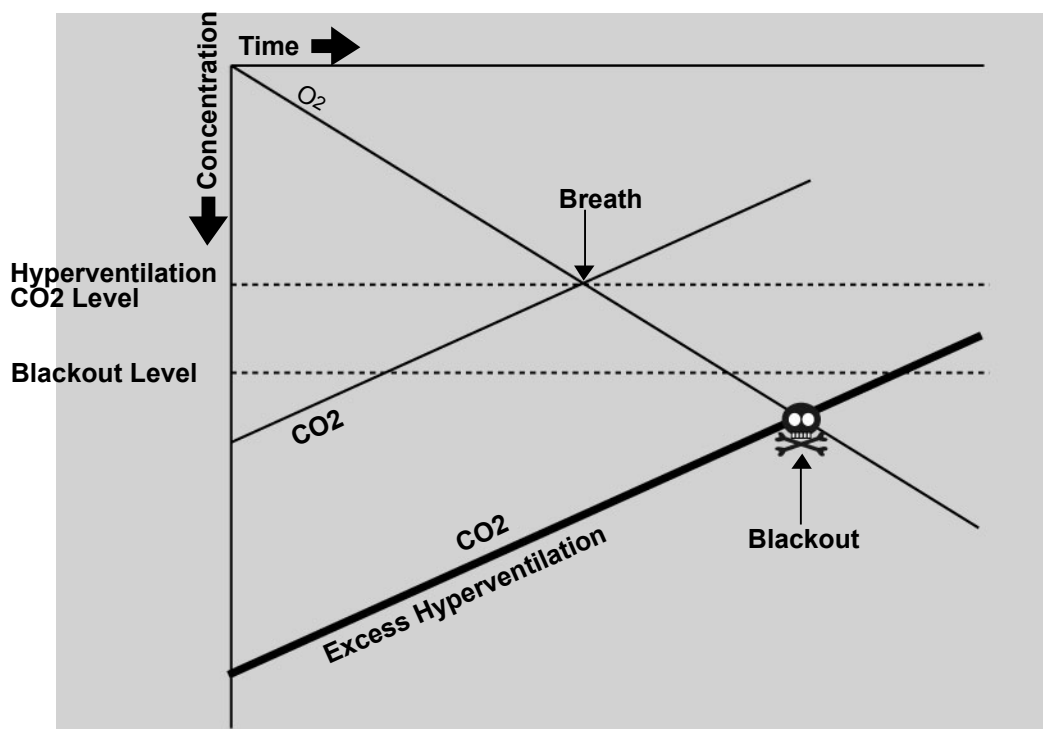

Structure of a Blackout

Skip Breathing

As a method for economizing on air consumption, if you hold every second breath as an “extra breath”, this is termed skip breathing. However, skip breathing increases carbon dioxide blood concentration, so the respiratory centre’s breathing stimulus is increased and your consumption increases. Further, symptoms such as headache and nausea are likely.



Decompression Sickness (DCS)

When diving, nitrogen is absorbed into the body. After surfacing, nitrogen is released during respiration (called off-gassing). This is a normal process, but if a large amount of nitrogen is absorbed and then the diver surfaces too quickly, the excess nitrogen forms bubbles in the body. Once these bubbles enter the bloodstream, the disruptions they cause are called decompression sickness (DCS).

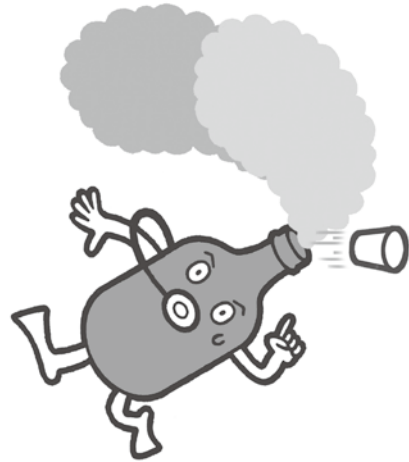

A Body Filled With Bubbles

[Symptoms of DCS]

As nitrogen absorption varies in the different areas of the body, there are distinct types of DCS - type I (mild); type II (serious) and type III (with Arterial Gas Embolization, or AGE). Type I is marked by dermatopathy such as skin rashes, itchiness, and the like, as well as joint pain (aka "The Bends"). Upper body joint pain is more prevalent, ranging from a dull ache to sharp needle-like pain. Type I DCS accounts for roughly 90% of cases. Less common is type II DCS, with pulmonary symptoms, hypovolemic shock, or nervous system involvement. Type II can leave residual complications, and may lead to death in the worst case scenario.

Undiagnosed, DCS can lead to things such as chronic joint pain and osteonecrosis.

The Bends

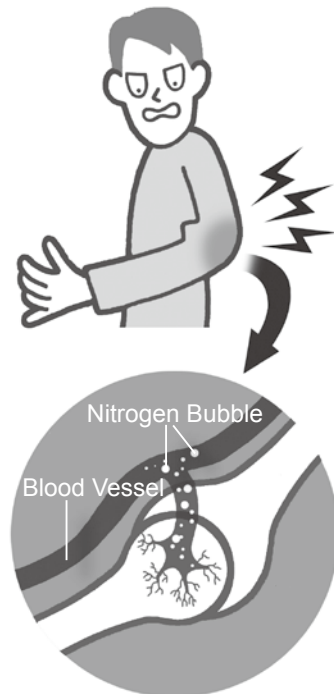

●●● Underwater Physiology ●●●

[Decompression Sickness Emergency Care and Prevention]

For emergency care, oxygen therapy (100% at 10-15L/min) and immediate transport to a hospital with recompression chamber is key. Prevention includes allowing your body to off-gas as much absorbed nitrogen as possible by slowly ascending from all dives, especially for deep and long dives. Use of dive computers is beneficial as they are programmed to give water depth, dive time, and other data which help you to prevent DCS. Further, they warn against rates of ascent that are too fast.

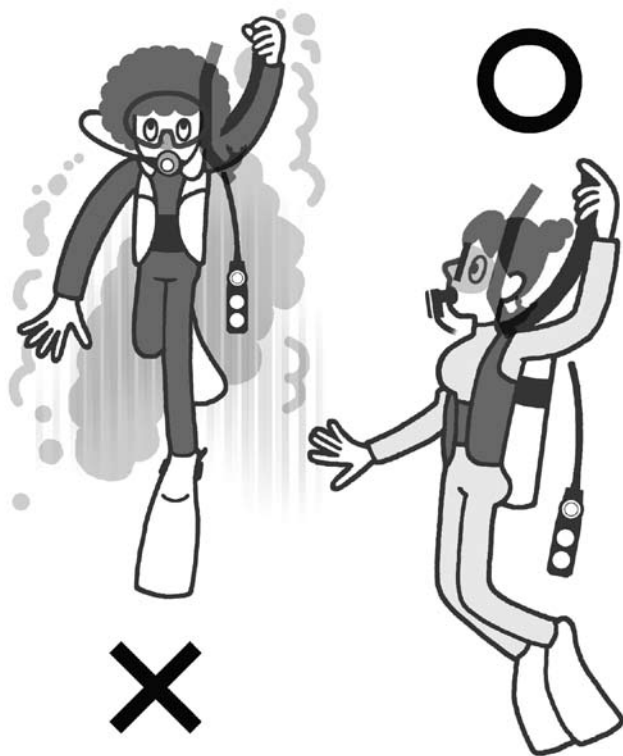

The Human Body's Air Spaces

In and around our bodies, there are many air spaces:

[Ear]

Our external ear is separated by the eardrum in the middle ear from our inner ear. While we hear by way of our middle ear's three ossicles, this tympanic cavity is not in direct contact with the atmosphere outside. Rather, the usually collapsed Eustachian tube connects from the chamber of the middle ear to the back of the pharynx. It is in our inner ear that we have our sense of hearing and sense of balance, by way of the connection of the cochlea to our brain.

[Sinus Cavity]

The sinus cavity consists of four, paired sites of air spaces on the skull in the region of our eyes, nose and cheeks. Sinuses are joined to the nasal cavity via small orifices called ostia. These become blocked relatively easily by colds and allergic inflammation, causing sinusitis. For divers, this can present a problem with pain due to unequal pressure ear equalization.

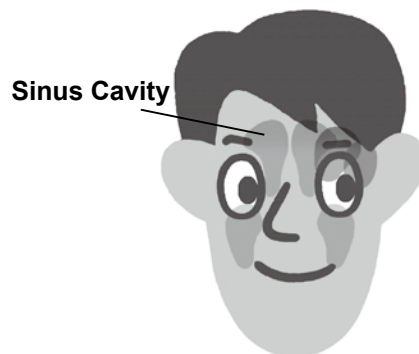
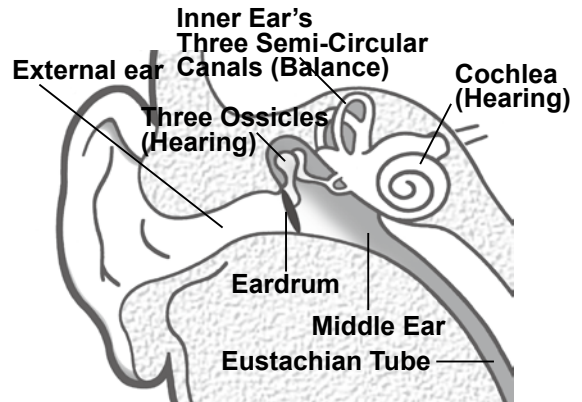
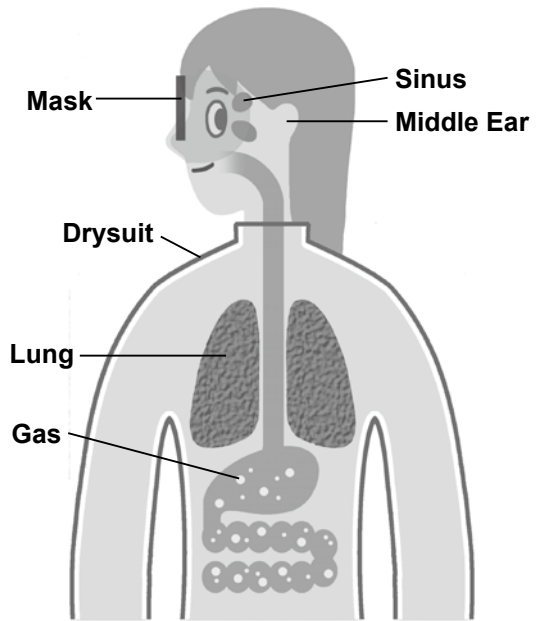

●●● Underwater Physiology ●●●

[Lungs]

In the lungs there exist numerous air spaces called alveoli. Breathing occurs as long as the flow of air to and from the alveoli via the trachea is uninterrupted.

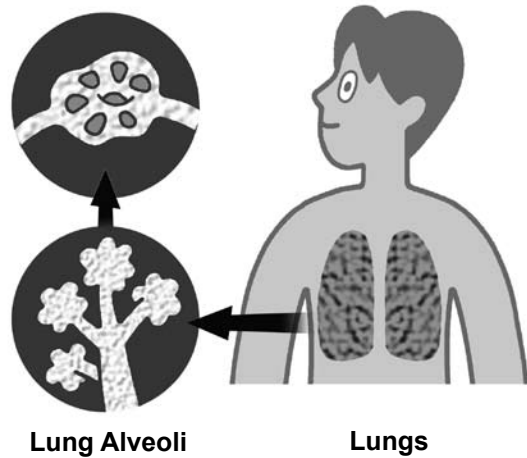

[Other]

Since dry suits are designed to keep water out, they form an air space around the body.

Dental care, such as fillings, can create spaces in teeth.

The wearing of a dive mask creates an artificial air space between mask and face.

Indigestion and drinking of carbonated drinks can create gas in the gastrointestinal system.

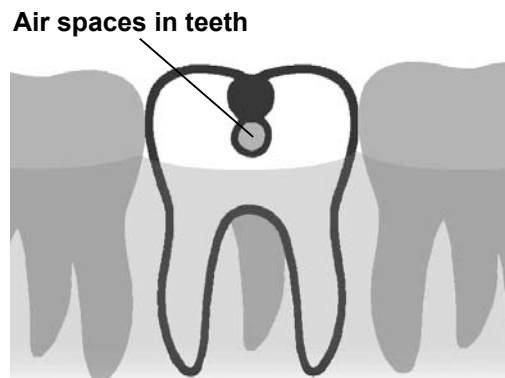
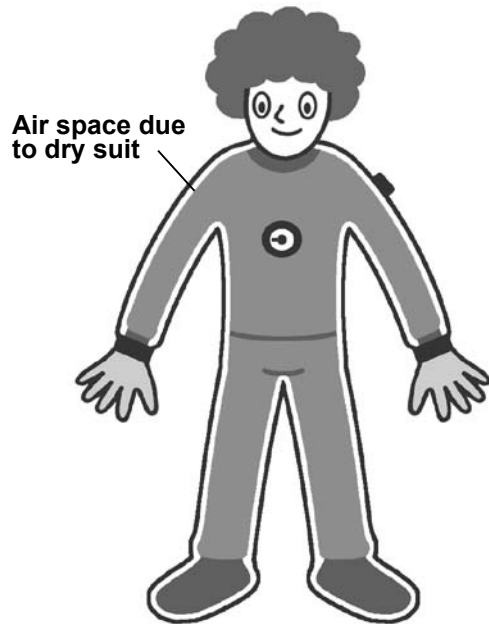

Squeeze and Equalization

When diving, we experience increased pressure. If there is a differential between external pressure and our body spaces, we feel an uncomfortable, if not painful, pulling sensation, a condition we call “squeeze”. To protect against worsening squeeze, if we start to feel a squeezing feeling, take measures to normalize pressure (called equalization), such as swimming at a shallower depth.



Common Squeeze

Specific Squeeze Types

[Middle Ear]

When the ear, normally adjusted to surface pressures, is exposed to increased pressure during diving, the middle ear's eardrum can feel painfully disturbed. In this case, we use the Valsalva maneuver to equalize pressure. The Valsalva maneuver is performed by forcibly exhaling at the same time you are pinching your nose while keeping your lips tightly closed. The action forces air into the middle ear via the Eustachian tube. However, you should take care not to overdo the maneuver to avoid auditory damage from over-pressurization. Swallowing and a yawning motion are some of the gentler methods that can work as well.

Improving Ear Equalization



Valsalva Maneuver

●●● Underwater Physiology ●●●

In order to prevent squeeze, you should equalize frequently and in advance of any pain developing. If you find it difficult to equalize, slowly ascending to a shallower depth should resolve the issue. As well, equalization is easier if you descend feet first from the surface. If discomfort or pain is ignored and you continue to descend, there is a risk of a perforated eardrum, which allows water to enter the middle and inner ear regions. Water's chilling effect on the cochlea causes excessive dizziness and malaise. In the case of this happening, grab hold of a rock or anchor-line to stabilize yourself, and once the water is warmed and balance somewhat restored, make an emergency ascent.

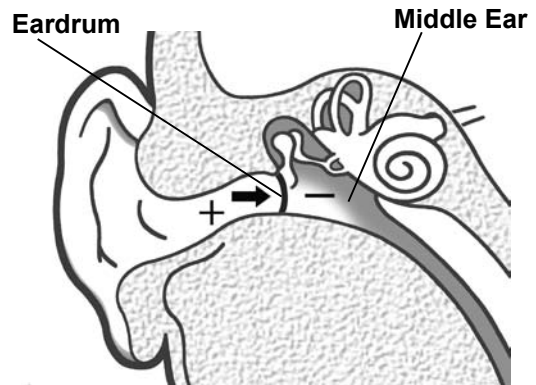

An Ear Affected by Squeeze

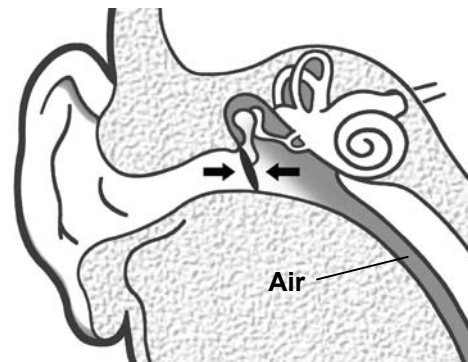

An Equalized Ear

●●●Underwater Physiology●●●

[Sinus]

Sinuses are joined to the nasal cavity via small orifices called ostia. These remain open and so pressure equalizes under normal conditions. However, these become blocked relatively easily by colds and allergic inflammation, causing sinusitis. For divers, this can present a problem with pain due to unequal ear pressure equalization. Most commonly, the sinus cavities in the forehead area become painful. In the worst case scenario, the pressure causes capillaries to break, causing bleeding in the sinus areas that pools in the throat area.

If you have a cold with blocked sinuses, don't dive.

[Lungs]

Even though at 40m depth lungs compress to 1/5 their normal size, pliable lungs can suffer squeeze. This is due to the unique phenomenon called "Blood Shift", where the blood gathers in the areas of the body due to pressure.

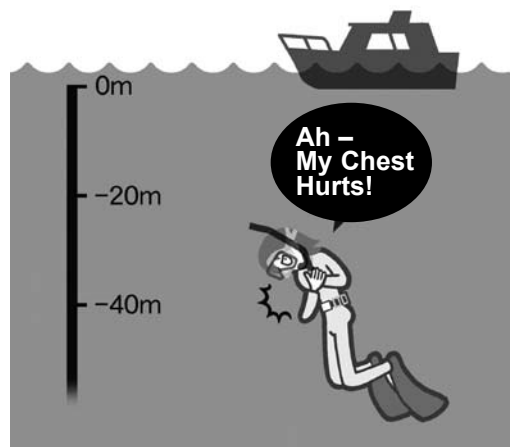
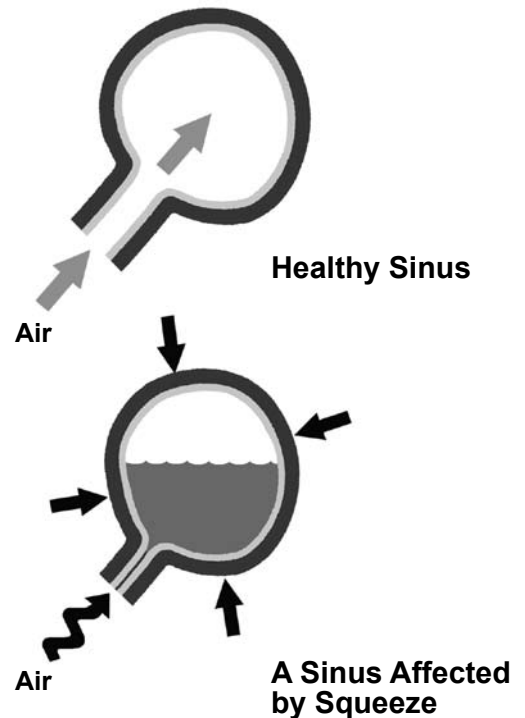

●●● Underwater Physiology ●●●

[Teeth]

Dental care, such as fillings, can create spaces in teeth in which nerves get pulled due to squeeze. This can be corrected by visiting your dentist.



[Mask]

If you feel mask squeeze, you can equalize by blowing air out from your nostrils into the mask. This is called “Mask Blow”. If you neglect to complete a necessary mask blow, the pulling can cause blood vessels in your eyes to rupture. In the worst case, this pooled blood can cause bruising in the eyes or around the face.



Mask Squeeze

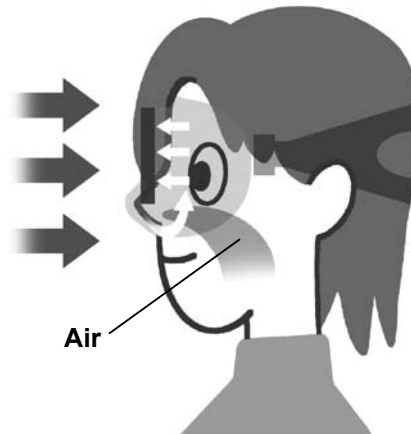

Mask Blow

Reverse Block and Equalization

When we ascend or surface from a dive, the pressure we experience naturally diminishes. However, pressure on our expanding body tissues can cause pain on ascent. This is called “Reverse Block”, and it is the opposite of squeeze.



Usual Reverse Block

Specific Body Air Cavities and Reverse Block

[Middle Ear]

If you feel reverse block pain in your middle ear upon ascending, descending briefly and then re-ascending slowly should resolve the issue. You can also move your jaws forwards and backwards, or swallow to stop the reverse block.

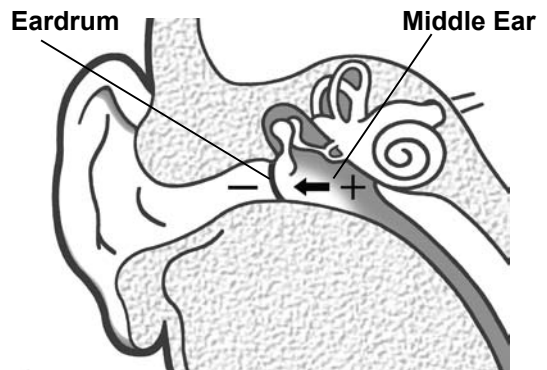

An Ear Experiencing Reverse Block

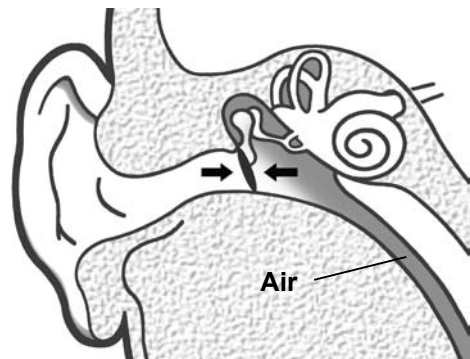

An Equalized Ear

●●● Underwater Physiology ●●●

[Sinus]

Whether due to irritation from a cold or allergies, or overdoing the valsalva maneuver, bleeding in the sinus cavities is a cause of reverse block. If you are experiencing any bleeding, you shouldn't dive.

